



Products: SMIQ

3GPP FDD Base Station Tests with Vector Signal Generator SMIQ

Application Note

This application note describes in detail how 3GPP FDD base stations can be tested with signal generators, according to 3GPP specification TS25.141. Nearly all of those tests can be performed using signal generators and analyzers. For each measurement, the recommended test setup and signal generator settings are given.



Contents

| | | |
|-----------|---|-----------|
| 1 | Introduction | 3 |
| 2 | 3GPP FDD Base Station Tests..... | 4 |
| 2.1 | Transmitter Characteristics..... | 4 |
| 2.2 | Receiver Characteristics..... | 4 |
| 2.3 | Performance Requirements..... | 6 |
| 3 | Signal Generator Solution for 3GPP FDD Base Station Tests | 7 |
| 3.1 | Generating 3GPP interferers (option SMIQB45) | 7 |
| 3.2 | Generating the wanted 3GPP Signal (options SMIQB45 and SMIQB48)..... | 8 |
| 3.3 | Generating AWGN and fading (options SMIQB14, B15, B49 and B17)..... | 9 |
| 3.4 | BER and BLER measurements with SMIQB21 | 10 |
| 4 | General Operation of SMIQ for 3GPP FDD | 11 |
| 4.1 | SMIQ main menu..... | 11 |
| 4.2 | WCDMA/3GPP menu..... | 12 |
| 4.3 | SMIQ preparations..... | 14 |
| 4.4 | Synchronizing the BS and SMIQ (clock and trigger)..... | 14 |
| 4.5 | Generating an uplink Reference Measurement Channel | 20 |
| 4.6 | Generating a W-CDMA interfering signal | 27 |
| 4.7 | Graphical representation of 3GPP signals..... | 32 |
| 5 | Transmitter Characteristics to 3GPP TS25.141..... | 33 |
| 5.1 | Output power dynamics | 33 |
| 5.2 | Transmit intermodulation | 37 |
| 6 | Receiver Characteristics to 3GPP TS 25.141 | 39 |
| 6.1 | General remarks..... | 39 |
| 6.2 | Reference sensitivity level | 39 |
| 6.3 | Dynamic range..... | 40 |
| 6.4 | Adjacent channel selectivity..... | 42 |
| 6.5 | Blocking characteristics | 44 |
| 6.6 | Intermodulation characteristics..... | 46 |
| 6.7 | Spurious emissions..... | 47 |
| 6.8 | Verification of the internal BER calculation..... | 47 |
| 7 | Performance Requirements to 3GPP TS 25.141 | 49 |
| 7.1 | General remarks | 49 |
| 7.2 | Demodulation of DCH in static propagation conditions | 49 |
| 7.3 | Demodulation of DCH in multipath fading conditions | 54 |
| 7.4 | Demodulation of DCH in moving propagation conditions | 56 |
| 7.5 | Demodulation of DCH in birth/death propagation conditions..... | 59 |
| 7.6 | Verification of the internal BLER calculation..... | 61 |
| 8 | Beyond the Standard: Additional Test Possibilities with SMIQ | 63 |
| 8.1 | Reduced setup for performance tests without receiver antenna diversity..... | 63 |
| 8.2 | Transmitting user-specific data..... | 63 |
| 9 | Abbreviations | 66 |
| 10 | References..... | 67 |
| 11 | Ordering information | 68 |

1 Introduction

This application note describes how 3GPP FDD base stations can be tested with signal generators. The conformance tests for 3GPP FDD base stations are described in the 3GPP document TS25.141 [2]. Nearly all of those tests can be performed using signal generators and analyzers. The tests are divided into three categories: Transmitter Characteristics, Receiver Characteristics and Performance Requirements. This application note focuses on the tests requiring signal generators. These are mainly the Receiver Characteristics and Performance Requirements tests. For Transmitter Characteristics, only the two tests are described where signal generators are involved. A complete survey of Transmitter Characteristics tests is given in reference [3].

If you are not familiar with 3GPP and Rohde & Schwarz signal generators, we recommend you read reference [1] first, which gives an introduction to 3GPP as well as an overview of signal generator solutions for different 3GPP applications. For 3GPP FDD base station tests, SMIQ Vector Signal Generators with appropriate 3GPP options are the best solution.

Section 2 describes briefly the 3GPP base station tests while section 3 gives an overview of the appropriate signal generator setup and the required options. Sections 4-7 describe how to perform 3GPP FDD base station tests with Rohde & Schwarz signal generators. Section 4 focuses on the SMIQ user interface and operation that is necessary for all tests. The other sections describe the individual tests, section 5 for Transmitter Characteristics, section 6 for Receiver Characteristics and section 7 for Performance Requirements. Section 8 contains some additional information that is not directly related to the 3GPP test specification.

This application note will help you to get familiar with SMIQ's 3GPP capabilities. Although you will find many step-by-step instructions, this is not a "SMIQ for dummies" guide. Furthermore, you will have to find out yourself, which test strategy is the best for you. This application notes describes the settings for different tests independently of each other, which will never be the optimum for a real test system. However, we will give some hints. If you want to use remote control via GPIB, you will find reference [8] very useful; an application note providing some demo programs as well as appropriate source code.

This application note applies to 3GPP FDD, so if we mention 3GPP, we always mean FDD.

2 3GPP FDD Base Station Tests

For 3GPP FDD base station tests, two specification documents are relevant: 3GPP TS 25.104 and TS 25.141.

There are three types of base station tests defined in the 3GPP specifications:

- Transmitter Characteristics
- Receiver Characteristics
- Performance Requirements

2.1 Transmitter Characteristics

TS 25.141 specifies the following tests for Transmitter Characteristics:

- Base Station Output Power
- Frequency Error
- Output Power Dynamics
- Output RF Spectrum Emissions
- Transmit Intermodulation
- Transmit Modulation

Transmitter tests are mainly a topic for spectrum analyzers and modulation analyzers. Most tests do not require signal generators. However, a signal generator is needed for Output Power Dynamics and Transmit Intermodulation tests. In the first case, the signal generator transmits an uplink signal to the base station (BS) including power control information (TPC bits). These TPC bits regulate the power of the corresponding downlink signal from the BS to this particular "mobile" (inner loop power control). The downlink signal is then analyzed to verify the base station's power control function. For transmit intermodulation, a signal generator is required to generate a 3GPP interferer.

These two tests are described in detail in section 5). For a complete survey of transmitter tests, including these for which signal generators are not required see [3] and [8].

2.2 Receiver Characteristics

TS 25.141 specifies the following tests for Receiver Characteristics:

- Reference Sensitivity Level
- Dynamic Range
- Adjacent Channel Selectivity
- Blocking Characteristics
- Intermodulation Characteristics
- Spurious Emissions

All receiver tests follow more or less one principle. A signal generator transmits an appropriate 3GPP signal, including channel coding. The wanted signal is defined in TS 25.141 and is known as the 12.2 kbps uplink Reference Measurement Channel. The base station under test receives, demodulates, despreads and decodes the signal. Then the bit error rate (BER) of the recovered user data bits is measured, either inside the base station or with an external BER tester. In some cases the transmitted signal is only varied in power, in others White Gaussian Noise or interfering signals are added. The interfering signals can be 3GPP signals or just unmodulated (CW) carriers.

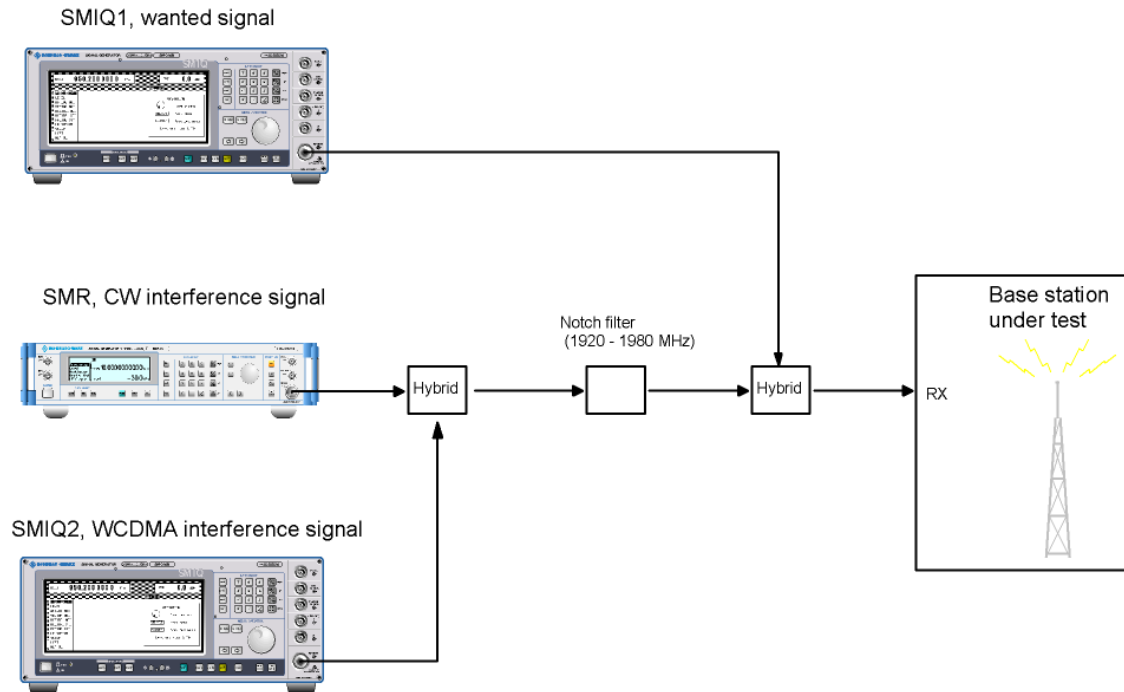

Fig. 2.1: Typical measurement setup for Receiver Characteristics

Receiver Characteristics tests require up to three signal generators. An SMIQ03 Vector Signal Generator with appropriate 3GPP options (SMIQ 1 in Fig. 2.1) generates the wanted 3GPP signal. A second SMIQ provides a 3GPP interfering signal (SMIQ 2 in Fig. 2.1). CW interferer frequencies range up to 12.75 GHz, therefore an SMR microwave signal generator is required. For low frequency CW interferers, SMIQ 2 can be used. Receiver Characteristics tests are described in section 6.

2.3 Performance Requirements

Performance tests check the base station's capability to receive and demodulate a signal correctly under real-environment conditions. Except for Additional White Gaussian Noise (AWGN), no interfering signals are present during the tests. The measurements cover four propagation conditions, actually three different fading scenarios and one scenario without fading. The measurements are:

- Demodulation in static propagation conditions
- Demodulation in multipath fading conditions
- Demodulation in moving propagation conditions
- Demodulation in birth-death propagation conditions

The tests are specified for base stations with dual receiver antenna diversity, i.e. two receiver antenna ports. In addition, the specifications define a bit energy / noise energy ratio to be applied separately at each antenna port. Therefore, two SMIQs are required for these measurements.

SMIQ1, wanted signal and AWGN/channel simul 1

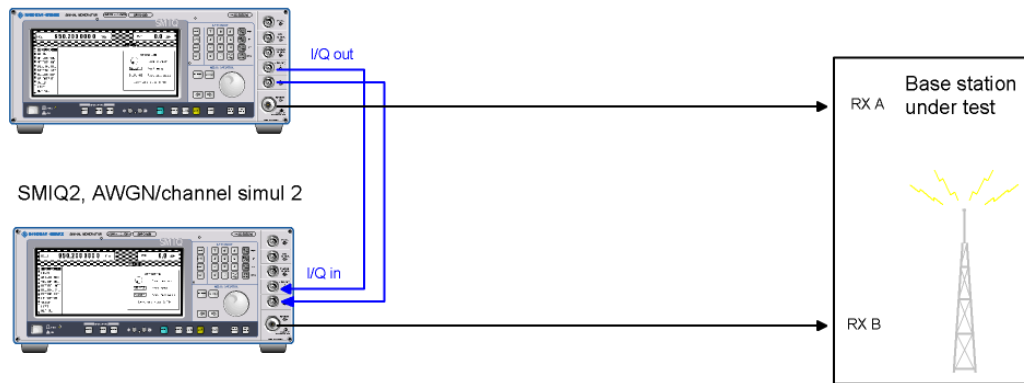

Fig. 2.2: Typical setup for Performance Characteristics tests.

SMIQ 1 generates the wanted 3GPP signal and provides the RF signal (including AWGN and fading) for antenna port A. In addition, the I/Q baseband signal from SMIQ 1 is connected to SMIQ 2, which is driven in external vector modulation mode and provides the signal for antenna port B.

The wanted 3GPP signal is again an uplink Reference Measurement Channel. This time the information bit rate can be 12.2 kbps, 64 kbps, 144 kbps or 384 kbps. The tests shall be performed for all Reference Measurement Channels that are supported by the base station. In Performance Requirements tests, the block error rate (BLER) rather than the BER is measured. As these are tests in real-environment conditions, the received signal has to be analyzed in the same way as by the base station receiver during operation in the network.

Performance Requirements measurements are described in section 7.

Table 2.1: Summary of Receiver Characteristics and Performance Requirements tests

| | Receiver Characteristics | Performance Requirements |
|---------------------|--------------------------|---|
| Wanted signal | uplink RMC 12.2 kbps | uplink RMC 12.2 kbps, 64 kbps, 144 kbps, 384 kbps |
| Interfering signals | AWGN, CW, W-CDMA | AWGN |
| Fading | no | yes |
| Measured quantity | BER | BLER |

3 Signal Generator Solution for 3GPP FDD Base Station Tests

For an overview of signal generator solutions for various 3GPP applications, see [1]. For 3GPP FDD base station tests, SMIQ Vector Signal Generators with appropriate 3GPP options are the best solution. This section describes the required options.

Options SMIQB45 and SMIQB48, with hardware options SMIQB20 and SMIQB11 as prerequisite, can generate the wanted 3GPP signals and the 3GPP interferers.

In addition, options SMIQB14, SMIQB15, SMIQB49 and SMIQB17 are required for some of the tests. SMIQB14, SMIQB15 (Fading Simulators) and SMIQB49 (3GPP Fading) provide the necessary fading capabilities, while SMIQB17 can generate noise (AWGN).

Furthermore, the Bit Error Rate Tester Option SMIQB21 can be used for bit error rate (BER) and block error rate (BLER) measurements.

3.1 Generating 3GPP interferers (option SMIQB45)

SMIQB45 - Digital Standard W-CDMA (3GPP FDD) - is the basic option for generating 3GPP FDD signals with the SMIQ Vector Signal Generator. (Note that hardware options SMIQB20 and SMIQB11 are prerequisite.) SMIQB45 generates downlink signals with up to 512 code channels and uplink signals with up to 4 mobiles. However, signal duration is limited to a maximum of 13 frames, and channel coding is not supported in SMIQB45. Therefore SMIQB45 alone is mainly used for measurements where the spectral and statistical properties of the signal are of more interest than the data content. SMIQB45 is suitable to test components such as amplifiers, for example.

With 3GPP FDD base station tests, SMIQB45 can be used to generate the following 3GPP signals:

- 3GPP interferer for Receiver Characteristics (Adjacent Channel Selectivity, Blocking Characteristics, Intermodulation Characteristics)
- 3GPP interferer for Transmitter Characteristics (Transmit Intermodulation)
- 3GPP uplink stimulus for Transmitter Characteristics (Output Power Control)

SMIQB45 features overview:

For more details see reference [1].

- 3GPP Test Models (as defined in the standard)
- Three different uplink modes such as "PRACH_ONLY", "PCPCH_ONLY" and "DPCCH+DPDCH"
- Simulating up to 4 base or mobile stations
- Up to 512 Code Channels in downlink
- Easy and fast settings menu "PARA. PREDEF SETTING..."
- Mobile synchronization via P-SCH, S-SCH, PCCPCH
- Graphical display of Complementary Cumulative Distribution Function (up to 3 traces), Constellation Diagram, Code Domain Power, Channel Graph and Domain Conflicts.

3.2 Generating the wanted 3GPP Signal (options SMIQB45 and SMIQB48)

SMIQB48 – Extended Functions for W-CDMA (3GPP FDD) - provides extended 3GPP functionality and is designed especially for receiver tests where full channel coding is required. **SMIQB45 is a prerequisite for installing SMIQB48.**

With 3GPP FDD base station tests, SMIQB48 can be used to generate the following 3GPP signals:

- Uplink Reference Measurement Channel (RMC) for Receiver Characteristics (12.2 kbps).
- Uplink RMC for Performance Requirements (12.2 kbps, 64 kbps, 144 kbps, 384 kbps).
- Bit error or block error insertion in RMCs to verify BS internal BER or BLER testers.

SMIQB48 features overview:

For more details see reference [1].

- Sequences with a length of up to 2044 frames for one channel.
- Data lists for data fields and TPC.
- Reference measurement channels including channel coding for up and downlink: 12.2 kbps, 64 kbps, 144 kbps, 384 kbps (TS 25.101/104/141), AMR speech 12.2 kbps (TS 25.944).
- Coded Broadcast Channel (BCH) with System Frame Number (SFN) in downlink
- Insertion of bit errors for verifying the internal BER tester of the base station under test.
- Insertion of block errors for verifying the internal BLER tester of the base station under test.
- Simulation of Orthogonal Channel Noise (OCNS).
- Simulation of up to 64 additional mobile stations.
- External control of code channel power in real time.

3.3 Generating AWGN and fading (options SMIQB14, B15, B49 and B17)

With option SMIQB49 - Fading Functions for W-CDMA (3GPP) - an SMIQ can generate the signals required to simulate all three fading scenarios defined in the 3GPP standard (multipath propagation, moving propagation and birth-death propagation). The SMIQ must be equipped with the Fading Simulators SMIQB14 (mandatory) and SMIQB15 (recommended).

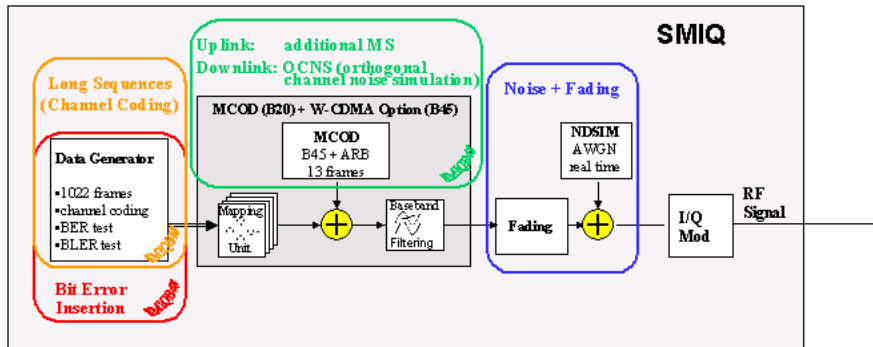

Fig. 3.1: Baseband signal processing for 3GPP W-CDMA, including noise generation and fading simulation

Option SMIQB17 – Noise Generator and Distortion Simulator - adds Gaussian noise to the signal to take the influence of neighbouring cells into consideration, for example.

3.4 BER and BLER measurements with SMIQB21

SMIQ can be extended for bit error rate or block error rate testing with option SMIQB21¹. The BER test option can analyze data of PRBS type. Therefore the user data of the code channel to be evaluated has to be PRBS. The BS has to demodulate the W-CDMA signal and return the user data as a serial bit stream. If the transmitted data was encoded, the BS must also decode the data. If the BS returns not only the user data but the whole frame including headers and other functional parts, the data has to be masked, so that only the user data part is counted. This mask signal also has to be provided by the BS.

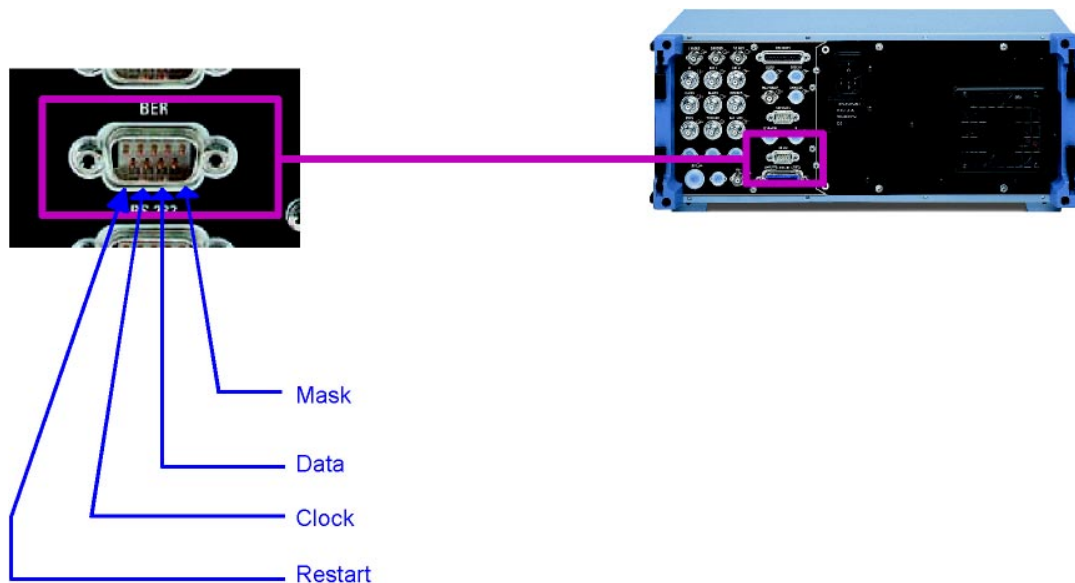

Fig. 3.2: Inputs of SMIQ BER and BLER option SMIQB21.

Generally, many frames are required to embed PRBS sequences into the W-CDMA data structure so that the PRBS is not truncated at the end of the sequence. The number of user data bits a W-CDMA slot contains differs from the cycle length of a PRBS. As PRBS lengths are always a prime number or a product of two prime numbers, they will never fit into a small number of frames. To ensure a signal with complete, non-truncated PRBS 9 user data, a sequence length of 511 frames is required. If one frame contains n data bits, then 511 frames can be filled with $n \cdot 511$ data bits, which is n times a complete PRBS 9. To measure the DTCH part of a 12.2 kbps uplink Reference Measurement Channel 1022 frames are required, due to the interleaver depth of the channel coding (see also section 4.5).

SMIQB48 can generate a fully coded 12.2 kbps Reference Measurement Channel with cyclic, non-truncated PRBS 9 sequences as user data. Therefore, restart signals for the BER tester are not necessary. Longer sequences also have the advantage that all possible states of the system are taken into account – otherwise the measurements may neglect significant situations that occur in real operation.

As the Bit Error Rate or Block Error Rate measurement is performed separately from the signal generation, the SMIQB21 functionality is not described in detail in this application note. For more information, see references [5], [6], and [7]².

¹ SMIQB21 requires the SMIQB20 Modulation Coder. For block error rate tests, SMIQ firmware 5.70HX or later is required.

² Some of these references are dealing with the BER option for AMIQ rather than SMIQ, but both options work in the same way.

4 General Operation of SMIQ for 3GPP FDD

This section describes how to operate SMIQ as required for all the tests. Functions related to particular tests are covered in the test descriptions in sections 5, 6 and 7. If you are not familiar with the 3GPP tests, you might want to read those sections first.

4.1 SMIQ main menu

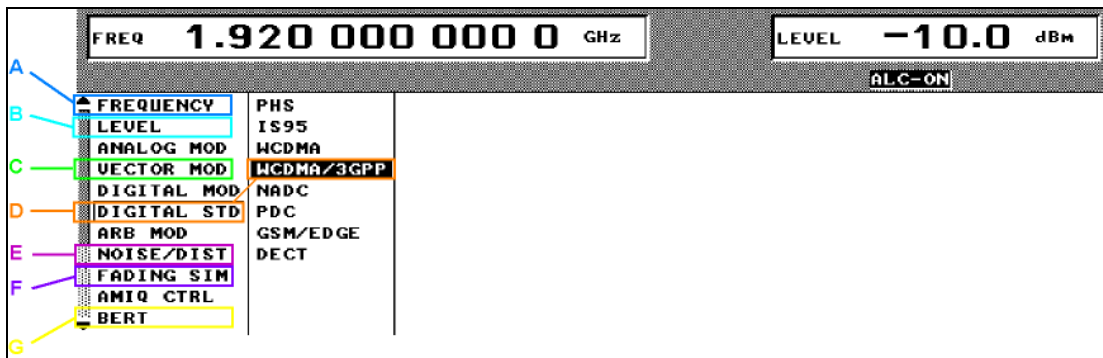

Fig. 4.1: SMIQ main menu and DIGITAL STD menu with WCDMA/3GPP

Fig. 4.1 shows the main menu of SMIQ (left) and the digital standards. Selection is from left to right, starting from SMIQs main menu on the far left. From left to right the menus become more specific. Only if a menu is too complex for this concept (e.g. a BS channel table), it takes the whole display.

The following menus are important for 3GPP FDD.

| | | |
|---|-------------|--|
| A | FREQUENCY | Sets the carrier frequency of the signal. Best reached via the FREQ hardkey. |
| B | LEVEL | Sets the RF level of the signal, i.e. the average power. Setting the RF level is best done via the LEVEL hardkey. The RF output can be optimized for specific ACP performance in LEVEL → LEVEL → OUTPUT MODE. This is important for generating W-CDMA interferers. Described in 6.4, 6.5 and 6.6 |
| C | VECTOR MOD | Includes some global settings for all I/Q modulated signals. The low ACP filter SMIQB47 is activated here. Important for W-CDMA interfering signals and for the Performance Requirements tests. Contains also the command for calibrating the I/Q modulator. Described in 6.4 and 7.2. |
| D | DIGITAL STD | Access to the 3GPP FDD menu (DIGITAL STD → WCDMA/3GPP). In this menu 3GPP signals are configured. See 4.2 for more information. |
| E | NOISE/DIST | Includes the parameters for AWGN generation. Described in 6.3 and 7.2 |
| F | FADING SIM | Access to the 3GPP channel simulation (fading) functions. Described in 7.3, 7.4 and 7.5 |
| G | BERT | Access to BER and BLER test functions. |

4.2 WCDMA/3GPP menu

To open the WCDMA/3GPP menu select DIGITAL STD → WCDMA/3GPP. The menu is divided into sections. If you go from the top of the menu to the bottom, the menu starts with the most general settings, followed by more and more specific parameters. We recommend to set parameters from the top to the bottom.

Note: Do not set WCDMA/3GPP STATE to ON before you have completed the settings!

Due to the limited screensize, the menu has to be scrolled during operation. But if the entire menu were visible, it would look like this:

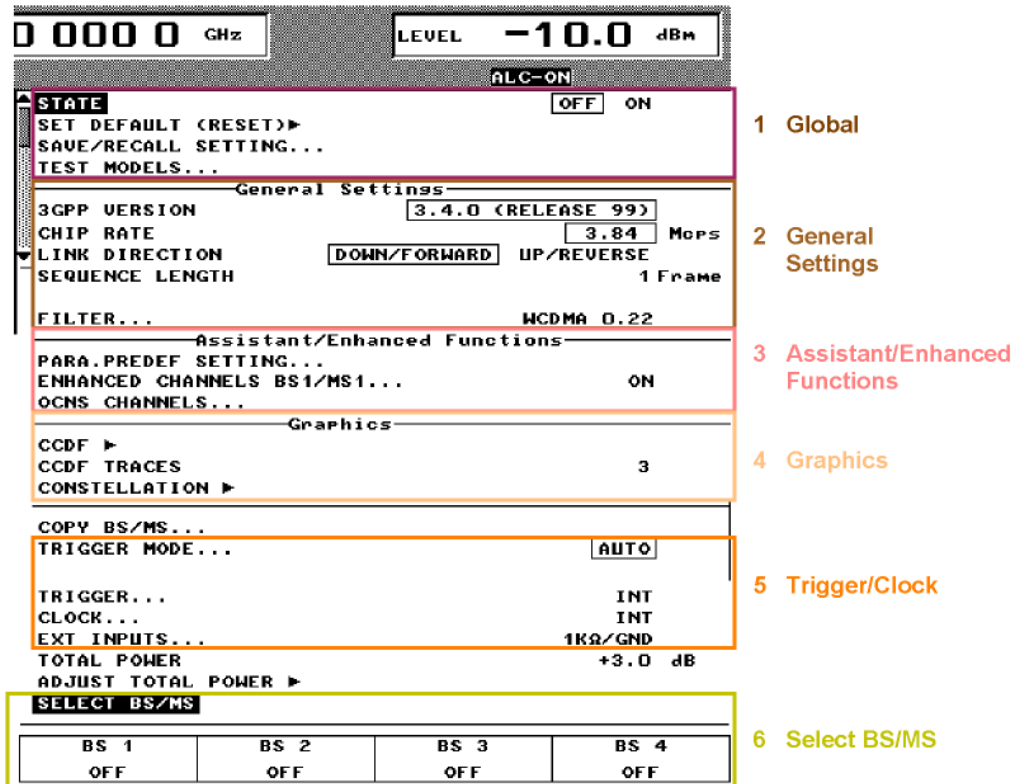

Fig. 4.2: Structure of the WCDMA/3GPP menu with sections that are important for 3GPP BS tests.

1. Global settings at the top of the menu:

| | |
|---------------------|--|
| STATE | Turns the 3GPP signal on or off. As the signal has to be pre-calculated, first set all the necessary parameters; and then switch on the modulation (STATE ON). |
| SET DEFAULT (RESET) | Turns off all base or mobile stations and all channels. Can be used as the starting point of a configuration, to make sure that no unwanted channels are active. |
| SAVE/RECALL SETTING | Saves or recalls a 3GPP signal configuration |
| TEST MODELS... | Predefined settings for spectral measurements. In downlink the 3GPP test models are available. In uplink no standard test models are defined, so this provides the most important configurations from experience. This function can be used to generate W-CDMA interfering signals (section 4.6) |

2. General 3GPP settings:

| | |
|-------------------|---|
| 3GPP VERSION | Shows the implemented 3GPP version (read only parameter) |
| CHIP RATE | Indicates the chip rate (3.84 Mcps; read only parameter) |
| LINK DIRECTION | Select uplink or downlink |
| SEQUENCE LENGTH | Sets the sequence length in frames. Acts on standard channels only. The standard channels can be 13 frames long maximum. Extended channels length is set in the Extended Channels menu. |
| CLIPPING LEVEL... | Clips the sum signal (before baseband filtering) to a settable percentage of the nominal peak level. Used in base stations in a similar way. Therefore mainly useful for BS component or MS receiver tests. |
| FILTER... | The default baseband filter is to the 3GPP standard. In this submenu the filter can be optimized either for low ACP or low EVM. Also other filters (cos or root cos) can be selected. |

3. Assistant / Enhanced functions:

| | |
|--|--|
| PARA. PREDEF SETTINGS... | Easy settings menu, especially for spectral measurements. Set a 3GPP signal by defining a number of channels and using the crest factor as optimization criterion. (Downlink only). This function can be used to generate W-CDMA interfering signals (section 4.6) |
| ENHANCED CHANNELS BS1/MS1... | Submenu to set the enhanced channels. Alternative access to set a wanted 3GPP signal (uplink Reference Measurement Channel in our case). See 4.5 for details. |
| OCNS CHANNELS...(in downlink) ADDITIONAL MOBILES BASED ON MS4... (in uplink) | Easy settings menu to set an OCNS (downlink) or additional mobiles (uplink) background signal for one or more Enhanced Channels. |

4. Graphics:

These graphics are related to the summed 3GPP signal. Graphics of single BS or MS (e.g. code domain power) can be found in the submenu of the individual BS or MS. See also 4.7.

| | |
|---------------|---|
| CCDF | Shows the complementary cumulative distribution function of the sum signal |
| CCDF TRACES | Number of CCDF curves to be shown in the same diagram. Max. = 3 |
| CONSTELLATION | Shows the constellation diagram of the sum signal (before baseband filtering) |

5. Trigger and clock settings:

| | |
|-----------------|---|
| TRIGGER MODE... | Trigger modes for output of 3GPP signals. See 4.4 for details. |
| TRIGGER... | Trigger in and out settings. See 4.4 for details. |
| CLOCK... | Clock settings. See 4.4 for details. |
| EXT INPUTS | Physical properties of trigger and clock inputs. See 4.4 for details. |

6. Select BS/MS:

| | |
|--------------|--|
| SELECT BS/MS | Opens the submenu for BS or MS specific settings. MS 1 includes access to the Enhanced Channels submenu to set a wanted 3GPP signal (uplink Reference Measurement Channel). See 4.5 for details. |
|--------------|--|

4.3 SMIQ preparations

Set SMIQ to PRESET state and clear the data generator memory, to remove unwanted "hidden" settings, especially in submenus.

Press the PRESET key

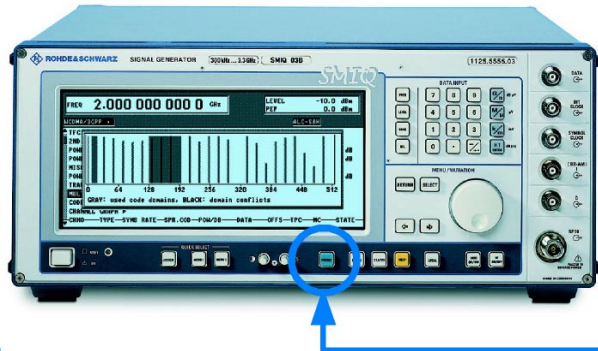

Clear data generator memory:

Select menu DIGITAL MOD
 →SOURCE→DELETE ALL
 DATA AND CONTROL LISTS

4.4 Synchronizing the BS and SMIQ (clock and trigger)

In most cases, the base station will play the role of the master in the setup. Although we will also describe the setup when SMIQ is master, we will assume in other sections of this application note that the base station is master.

4.4.1 Setup when the BS is master

Fig. 4.3 shows the setup when the BS is master.

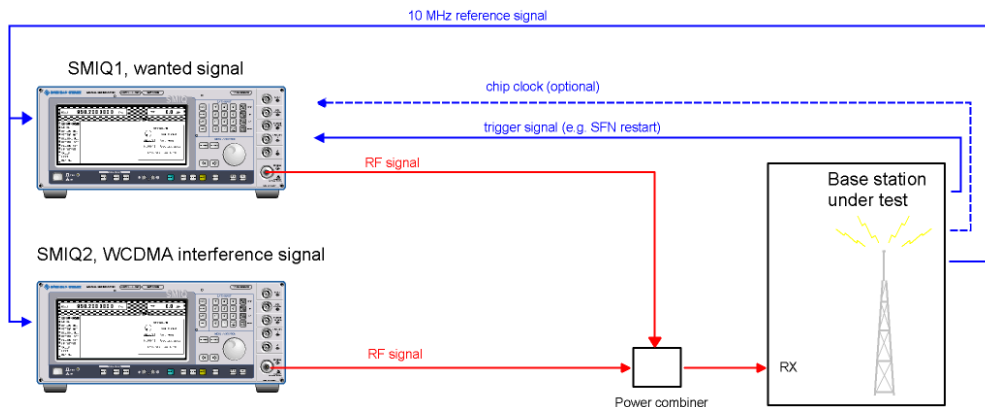

Fig. 4.3: Synchronizing BS and signal generators. The BS provides a 10 MHz reference signal for all devices. To start the wanted 3GPP signal from SMIQ 1, the BS provides a trigger signal, for example an SFN restart signal. For chip synchronization of the BS and SMIQ 1, the BS can deliver a chip clock for the signal generator.

Fig. 4.4 shows the SMIQ connectors for synchronization signals.

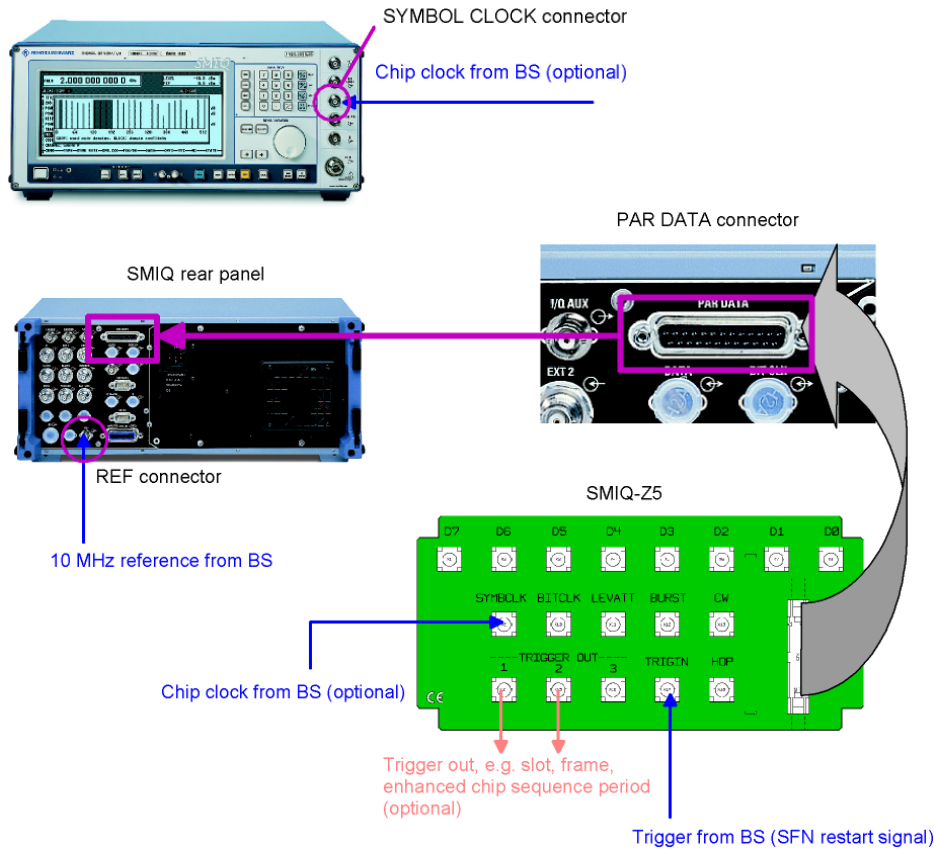

Fig. 4.4: SMIQ connectors for synchronization signals. Connect the 10 MHz reference signal to the REF connector on SMIQ's rear panel. The trigger inputs and outputs are available at the PAR DATA connector on the rear panel. The chip clock can either be fed into the SYMBOL CLOCK connector on the front panel or the SYMBOL CLOCK pin on the PAR DATA connector. SMIQ-Z5 is an adaptor board that provides BNC connectors for all pins of the PAR DATA connector.

4.4.2 SMIQ settings when BS is master

| | | | |
|---------------------------------|----------------|------------------------|-----|
| FREQ 1.920 000 000 0 GHz | | LEVEL -10.0 dBm | |
| DIGITAL MOD | | ALC-ON | |
| DIGITAL STD | SYSTEM REF OSC | INT | EXT |
| ARB MOD | PHASE | 10 MHz | |
| NOISE/DIST | PROTECT | OFF | ON |
| FADING SIM | CALIB | 1 400 | |
| BERT | DIAG | | |
| LF OUTPUT | TEST | | |
| SWEEP | MOD KEY | | |
| LIST | AUX I/O | | |
| MEM SEQ | BEEPER | | |
| UTILITIES | INSTALL | | |

10 MHz Reference:

In the menu UTILITIES → REF OSC set SOURCE to EXT

This has to be done for all signal generators in the setup. All generators must get a 10 MHz reference signal from the BS.

IEC/IEEE bus command:

: SOUR:ROSC:SOUR EXT

3GPP BS Tests with SMIQ

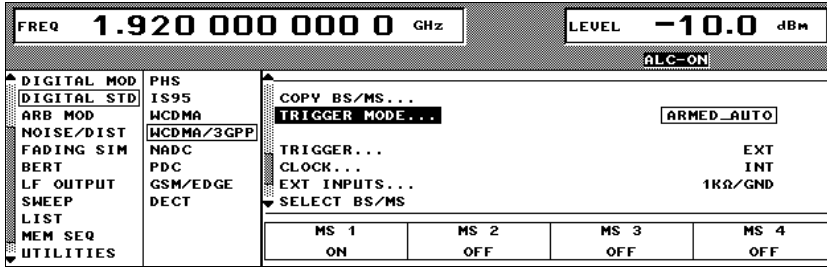

Trigger signals are set in the menu DIGITAL STD → WCDMA/3GPP

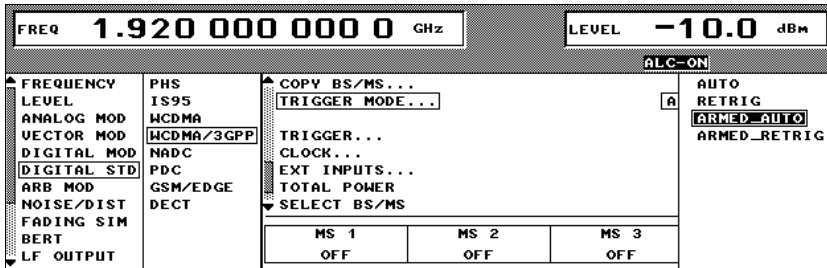

Set the trigger mode to ARMED AUTO. SMIQ will not start the signal output until it gets a trigger pulse from the BS.

IEC/IEEE bus command:

: SOUR:W3GP:SEQ AAUT

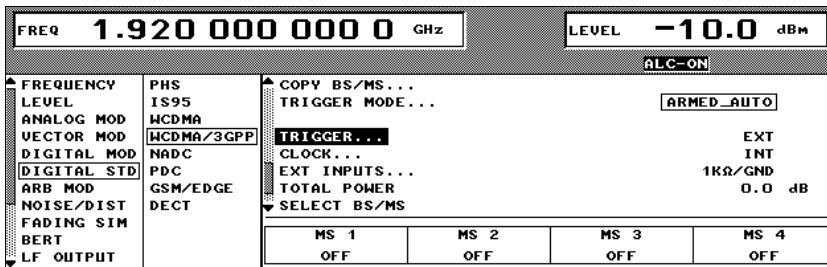

In the submenu TRIGGER... set trigger source to EXTERNAL

SMIQ has to be triggered by the base station with a downlink frame synchronous trigger signal (e.g. SFN restart). The 1024 chip delay of the uplink frame is done automatically inside SMIQ. (connect the BS trigger to the TRIGIN pin of the SMIQ par data connector or SMIQ-Z5)

IEC/IEEE bus command:

: SOUR:W3GP:TRIG:SOUR EXT

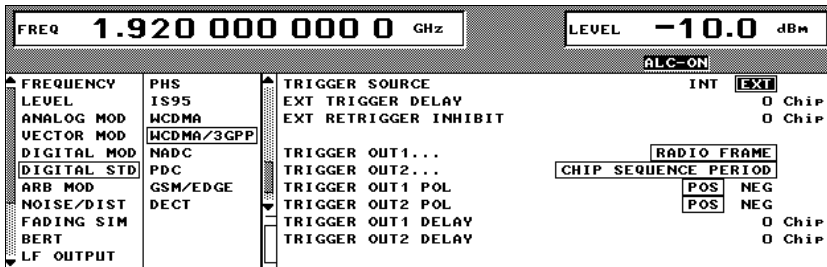

Clock Settings:

If the chip clock is provided by the BS, set CLOCK SOURCE to EXT in the submenu CLOCK....

IEC/IEEE bus command:

: SOUR:W3GP:CLOC:SOUR EXT

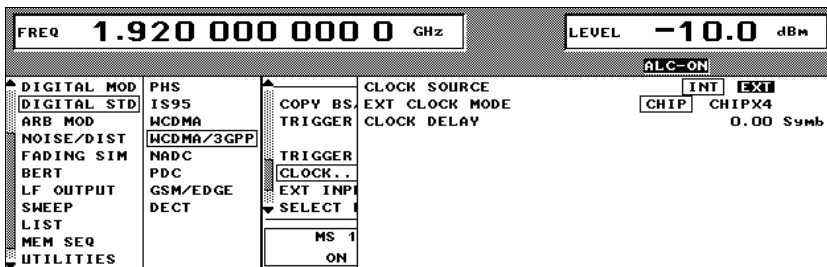

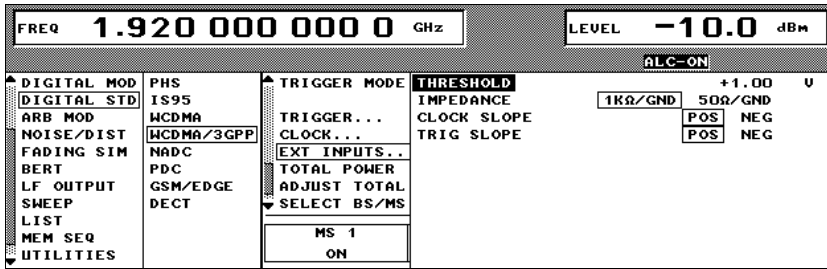

General Settings:

Set the physical properties of the connectors such as threshold, impedance and slope in the submenu EXT INPUTS...

Additional hint:

- In many cases the BS only provides a frame trigger. If a frame trigger is used to start signal generation, the TRIGGER INHIBIT function should be used to suppress unwanted trigger events. The trigger inhibit interval should be set to the sequence length of the Enhanced Channel. The sequence length is given in frames, the trigger inhibit interval can be set in units of chips to allow fine tuning. One frame has 38400 chips. If, for example, the Enhanced Channel is 1022 frames long, the trigger inhibit interval should be set to 1022×38400 chips = 3924480 chips. Otherwise every frame trigger event would restart the Enhanced Channel, which is not desirable in most cases.

4.4.3 Setup when SMIQ is master

The setup is shown below.

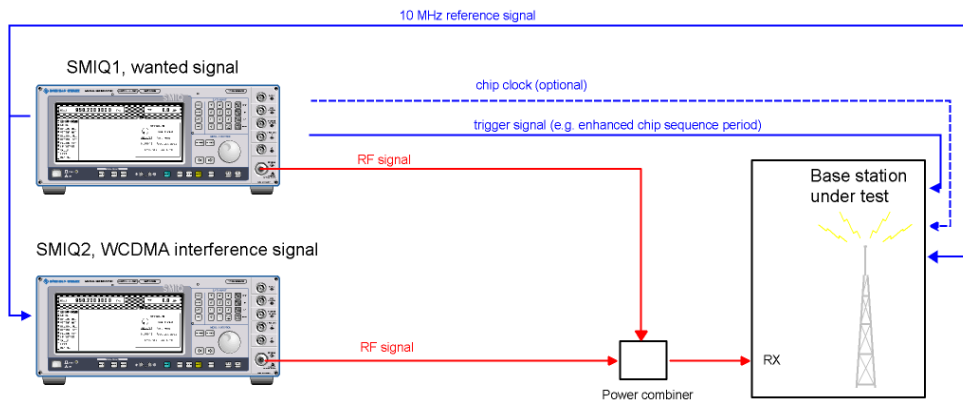

Fig. 4.5: Setup example for synchronizing BS and signal generators. SMIQ 1 provides a 10 MHz reference signal for all devices. SMIQ 1 also provides a trigger signal, indicating the start of the wanted 3GPP signal. For chip synchronization of the BS and SMIQ 1, the signal generator can deliver a chip clock.

Fig. 4.6 shows the related SMIQ connectors.

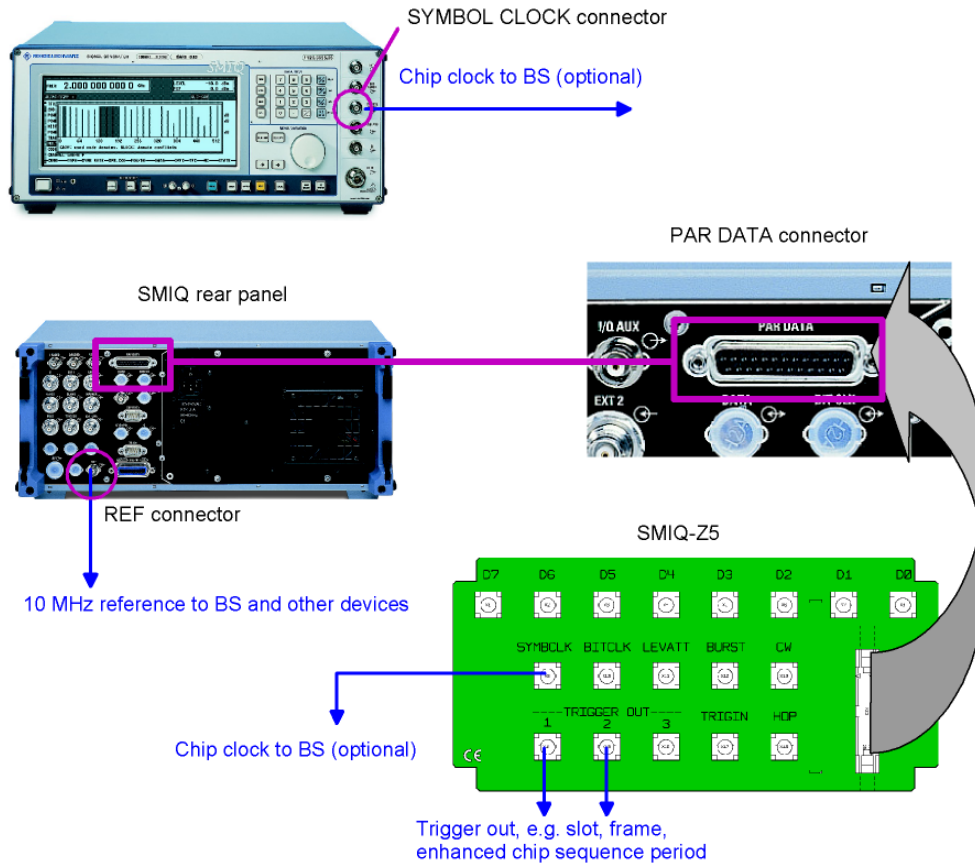
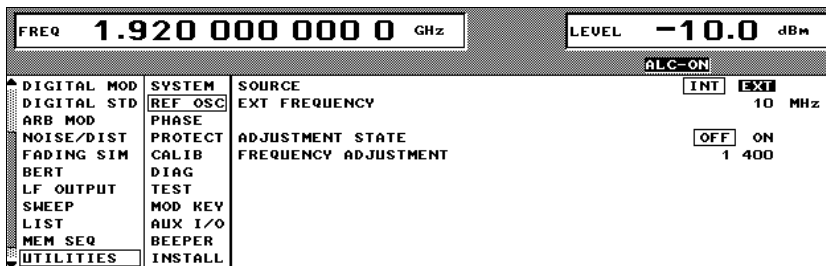

Fig. 4.6: SMIQ connectors for synchronization signals. The 10 MHz reference signal is provided at the REF connector on SMIQ's rear panel. The trigger inputs and outputs are provided at the PAR DATA connector on the rear panel. The chip clock can either be taken from the SYMBOL CLOCK connector on the front panel or the SYMBOL CLOCK pin on the PAR DATA connector. SMIQ-Z5 is an adaptor board that provides BNC connectors for all pins of the PAR DATA connector.

4.4.4 SMIQ settings when SMIQ is master



10 MHz Reference:

In the menu UTILITIES → REF OSC set SOURCE to INT (This is the default value after PRESET.)

If this SMIQ is the master for the entire setup, all other devices must be set to external reference.

IEC/IEEE bus command:

: SOUR:ROSC:SOUR INT

3GPP BS Tests with SMIQ

| | | | |
|---|---|---|-----------------------|
| FREQ 1.920 000 000 0 GHz | | LEVEL -10.0 dBm | |
| ALC-ON | | | |
| DIGITAL MOD DIGITAL STD ARB MOD NOISE/DIST FADING SIM BERT LF OUTPUT SWEPT LIST MEM SEQ UTILITIES | PHS IS95 WCDMA WCDMA/3GPP NADC PDC GSM/EDGE DECT | COPY BS/MS... TRIGGER MODE... ARMED_AUTO | |
| | | TRIGGER... CLOCK... EXT INPUTS... SELECT BS/MS | EXT INT 1KΩ/GND |
| | | MS 1 ON | MS 2 OFF |
| | | MS 3 OFF | MS 4 OFF |

Trigger signals are set in the menu DIGITAL STD → WCDMA/3GPP

| | | | |
|--|---|--|-------------|
| FREQ 1.920 000 000 0 GHz | | LEVEL -10.0 dBm | |
| ALC-ON | | | |
| FREQUENCY LEVEL ANALOG MOD VECTOR MOD DIGITAL MOD DIGITAL STD ARB MOD NOISE/DIST FADING SIM BERT LF OUTPUT | PHS IS95 WCDMA WCDMA/3GPP NADC PDC GSM/EDGE DECT | COPY BS/MS... TRIGGER MODE... AUTO RETRIG ARMED_AUTO ARMED_RETRIG | |
| | | TRIGGER... CLOCK... EXT INPUTS... TOTAL POWER SELECT BS/MS | |
| | | MS 1 OFF | MS 2 OFF |
| | | MS 3 OFF | |

Set trigger mode to ARMED AUTO. SMIQ will not start signal output until it gets a trigger signal. Here the trigger signal will either be sent via GPIB or given manually (see below).

IEC/IEEE bus command:

:SOUR:W3GP:SEQ AAUT

| | | | |
|--|---|--|---------------------------------|
| FREQ 1.920 000 000 0 GHz | | LEVEL -10.0 dBm | |
| ALC-ON | | | |
| FREQUENCY LEVEL ANALOG MOD VECTOR MOD DIGITAL MOD DIGITAL STD ARB MOD NOISE/DIST FADING SIM BERT LF OUTPUT | PHS IS95 WCDMA WCDMA/3GPP NADC PDC GSM/EDGE DECT | COPY BS/MS... TRIGGER... ARMED_AUTO | |
| | | TRIGGER... CLOCK... EXT INPUTS... TOTAL POWER SELECT BS/MS | EXT INT 1KΩ/GND 0.0 dB |
| | | MS 1 OFF | MS 2 OFF |
| | | MS 3 OFF | MS 4 OFF |

In the submenu TRIGGER...set trigger source to INTERNAL (this is the default value after PRESET)

IEC/IEEE bus command:

:SOUR:W3GP:TRIG:SOUR INT

| | | | |
|--|---|--|---|
| FREQ 1.920 000 000 0 GHz | | LEVEL -10.0 dBm | |
| ALC-ON | | | |
| FREQUENCY LEVEL ANALOG MOD VECTOR MOD DIGITAL MOD DIGITAL STD ARB MOD NOISE/DIST FADING SIM BERT LF OUTPUT | PHS IS95 WCDMA WCDMA/3GPP NADC PDC GSM/EDGE DECT | TRIGGER SOURCE INT EXT | |
| | | EXT TRIGGER DELAY EXT RETRIGGER INHIBIT | 0 Chip 0 Chip |
| | | TRIGGER OUT1... TRIGGER OUT2... TRIGGER OUT1 POL TRIGGER OUT2 POL TRIGGER OUT1 DELAY TRIGGER OUT2 DELAY | RADIO FRAME CHIP SEQUENCE PERIOD POS NEG POS NEG 0 Chip 0 Chip |

| | | | |
|--|---|--|---------------------------------|
| FREQ 1.920 000 000 0 GHz | | LEVEL -10.0 dBm | |
| PEP -4.6 dBm | | | |
| ALC-S&H | | | |
| FREQUENCY LEVEL ANALOG MOD VECTOR MOD DIGITAL MOD DIGITAL STD ARB MOD NOISE/DIST FADING SIM BERT LF OUTPUT | PHS IS95 WCDMA WCDMA/3GPP NADC PDC GSM/EDGE DECT | COPY BS/MS... TRIGGER MODE... ARMED_AUTO | |
| | | EXECUTE TRIGGER ▶ TRIGGER... CLOCK... EXT INPUTS... TOTAL POWER SELECT BS/MS | INT INT 1KΩ/GND 0.0 dB |
| | | BS 1 ON | BS 2 OFF |
| | | BS 3 OFF | BS 4 OFF |

After calculation of the 3GPP signal, the output can be started with EXECUTE TRIGGER ▶ in the WCDMA/3GPP main menu

IEC/IEEE bus command:

:TRIG:DM:IMM

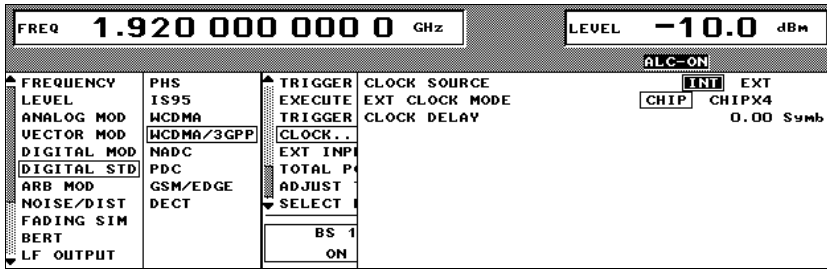

Clock Settings:

In the submenu CLOCK... set CLOCK SOURCE to INT if SMIQ shall provide a chip clock signal (this is the default value after preset)

IEC/IEEE bus command:

: SOUR:W3GP:CLOC:SOUR INT

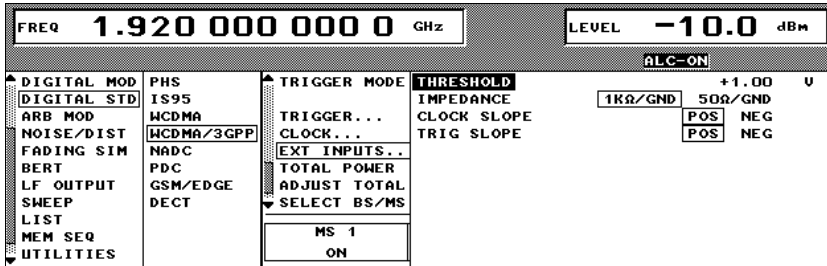

General Settings:

Physical properties of the connectors as threshold, impedance and slope can be set in the submenu EXT INPUTS...

4.5 Generating an uplink Reference Measurement Channel

4.5.1 Properties of uplink Reference Measurement Channels

In all tests for Receiver Characteristics and Performance Requirements, the "wanted" 3GPP signal to be demodulated must be an uplink Reference Measurement Channel (uplink RMC). The information data rates are 12.2 kbps for Receiver Characteristics tests and 12.2 kbps, 64 kbps, 144 kbps, 384 kbps for Performance Characteristics tests.

RMCs include channel coding. Fig. 4.7 shows the channel coding structure of a 12.2 kbps RMC.

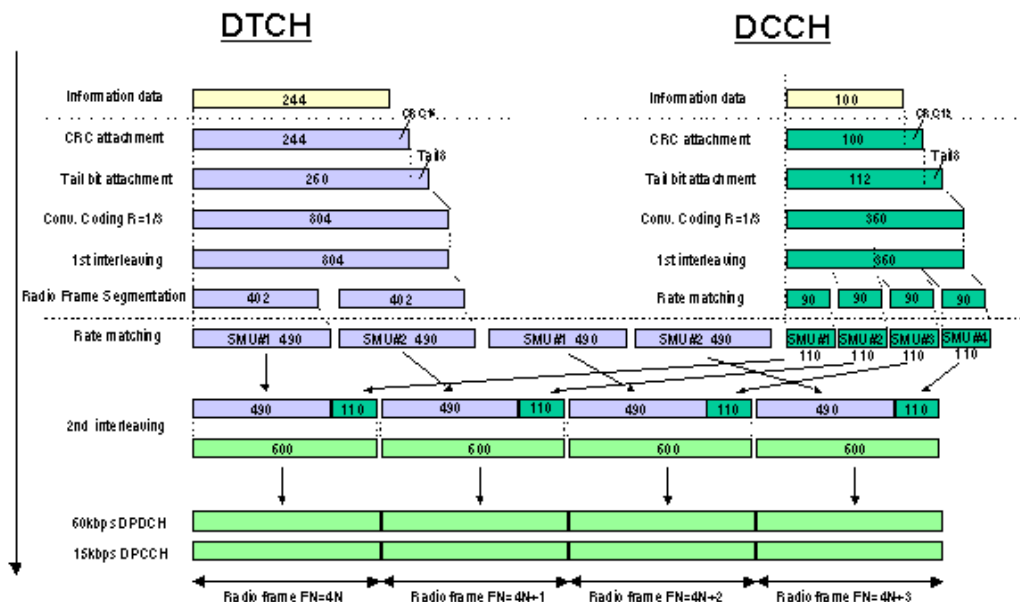

Fig. 4.7 Structure of the 12.2 kbps uplink Reference Measurement Channel.

Two transport channels, the Dedicated Traffic Channel (DTCH) and the Dedicated Control Channel (DCCH) are mapped to the Dedicated Physical Data Channel (DPDCH). The DCCH contains higher layer control information and is normally not evaluated in the tests covered here. The DTCH carries the user data.

The channel coding process starts at the top of the figure. From every information data block of the DTCH (244 bits) a CRC value is calculated and attached to the block. After adding 8 tail bits, convolutional coding and first interleaving are applied. The result is split into two parts to fit in two radio frames at the end of the process. The process for the DCCH is similar, but the information data block (100 bits) is split into four parts. After a rate matching algorithm, the second interleaver is applied. The DTCH data is distributed to two, the DCCH data to four consecutive radio frames.

In Receiver Characteristics measurements, the Bit Error Rate of the DTCH user data is measured. As described in section 3.4, we need 511 data information blocks to get non-truncating PRBS 9 sequences. This requires 1022 DPDCH radio frames.

In Performance Requirements measurements, the Block Error Rate is measured. The received signal is demodulated and decoded. For every decoded information data block the CRC is calculated and compared to the received CRC value. If either information bits or CRC bits are erroneous, the calculated and received CRC will not match, and the block will be invalid. The Block Error Rate is the ratio:

$$BLER = \frac{\text{number of invalid blocks}}{\text{number of received blocks}}$$

For BLER measurements the nature of the information data is not important. Therefore, the number of DPDCH radio frames need not equal 1022. However, the number of radio frames must be a multiple of 2 if only DTCH blocks are evaluated and a multiple of 4 if DTCH and DCCH are measured. As longer sequences generally lead to more realistic statistics, a sequence length of 1020 or 1024 frames is recommended.

The following subsections show how to operate SMIQ to generate uplink Reference Measurement Channels.

4.5.2 General W-CDMA settings

This step includes general settings such as link direction, trigger mode and source, and so on. In this example the base station is the master for the system. For a detailed discussion of clock and trigger settings see also 4.4.

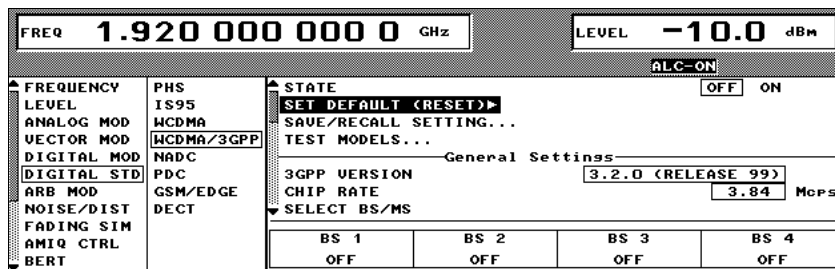

Select menu DIGITAL STANDARD
→ WCDMA/3GPP

Do not set the W-CDMA STATE to ON before you have done all necessary settings.

First reset the W-CDMA setup to make sure that no unwanted channel is active:

Choose SET DEFAULT (RESET) in the WCDMA/3GPP menu

IEC/IEEE bus command:

: SOUR : W3GP : PRES

3GPP BS Tests with SMIQ

FREQ **1.920 000 000 0** GHz LEVEL **-10.0** dBm

ALC-ON

| | | | | | |
|--|------------|------------------|--------------------------------|------|------|
| FREQUENCY LEVEL ANALOG MOD VECTOR MOD DIGITAL MOD DIGITAL STD ARB MOD NOISE/DIST FADING SIM AMIQ CTRL BERT | PHS | General Settings | | | |
| | IS95 | 3GPP VERSION | 3.4.0 (RELEASE 99) | | |
| | WCDMA | CHIP RATE | 3.84 Mcps | | |
| | WCDMA/3GPP | LINK DIRECTION | DOWN/FORWARD UP/REVERSE | | |
| | NADC | SEQUENCE LENGTH | 1 Frame | | |
| | PDC | CLIPPING LEVEL | 100 % | | |
| | GSM/EDGE | FILTER... | WCDMA 0.22 | | |
| | DECT | SELECT BS/MS | | | |
| | | MS 1 | MS 2 | MS 3 | MS 4 |
| | | OFF | OFF | OFF | OFF |

Set link direction to UP/REVERSE

IEC/IEEE bus command:

: SOUR:W3GP:LINK REV

FREQ **1.920 000 000 0** GHz LEVEL **-10.0** dBm

ALC-ON

| | | | | | |
|--|------------|-----------------|------|------|-------------------|
| FREQUENCY LEVEL ANALOG MOD VECTOR MOD DIGITAL MOD DIGITAL STD ARB MOD NOISE/DIST FADING SIM BERT LF OUTPUT | PHS | COPY BS/MS... | | | AUTO |
| | IS95 | TRIGGER MODE... | | | RETRIG |
| | WCDMA | | | | ARMED_AUTO |
| | WCDMA/3GPP | TRIGGER... | | | ARMED_RETRIG |
| | NADC | CLOCK... | | | |
| | PDC | EXT INPUTS... | | | |
| | GSM/EDGE | TOTAL POWER | | | |
| | DECT | SELECT BS/MS | | | |
| | | MS 1 | MS 2 | MS 3 | |
| | | OFF | OFF | OFF | |

Set trigger mode to ARMED AUTO. This allows a synchronized start of signal output. For synchronization between SMIQ and the BS. See also section 4.4.

IEC/IEEE bus command:

: SOUR:W3GP:SEQ AAUT

FREQ **1.920 000 000 0** GHz LEVEL **-10.0** dBm

ALC-ON

| | | | | | |
|--|------------|-------------------|------|------|-------------------|
| FREQUENCY LEVEL ANALOG MOD VECTOR MOD DIGITAL MOD DIGITAL STD ARB MOD NOISE/DIST FADING SIM BERT LF OUTPUT | PHS | COPY BS/MS... | | | ARMED_AUTO |
| | IS95 | TRIGGER MODE... | | | |
| | WCDMA | TRIGGER... | | | EXT |
| | WCDMA/3GPP | CLOCK... | | | INT |
| | NADC | EXT INPUTS... | | | 1kΩ/GND |
| | PDC | TOTAL POWER | | | 0.0 dB |
| | GSM/EDGE | SELECT BS/MS | | | |
| | DECT | | | | |
| | | MS 1 | MS 2 | MS 3 | MS 4 |
| | | OFF | OFF | OFF | OFF |

In the submenu TRIGGER...set trigger source to EXTERNAL

SMIQ has to be triggered by the base station with a downlink frame synchronous trigger signal (e.g. SFN restart). The 1024 chip delay of the uplink frame is achieved automatically inside SMIQ. (connect the BS trigger to TRIGIN pin of SMIQ PAR DATA connector or SMIQ-Z5). See section 4.4 for more information.

IEC/IEEE bus command:

: SOUR:W3GP:TRIG:SOUR EXT

FREQ **1.920 000 000 0** GHz LEVEL **-10.0** dBm

ALC-ON

| | | | | | | |
|--|------------|-----------------------|--|--|-----------------------------|------------|
| FREQUENCY LEVEL ANALOG MOD VECTOR MOD DIGITAL MOD DIGITAL STD ARB MOD NOISE/DIST FADING SIM BERT LF OUTPUT | PHS | TRIGGER SOURCE | | | INT | EXT |
| | IS95 | EXT TRIGGER DELAY | | | 0 | Chip |
| | WCDMA | EXT RETRIGGER INHIBIT | | | 0 | Chip |
| | WCDMA/3GPP | TRIGGER OUT1... | | | RADIO FRAME | |
| | NADC | TRIGGER OUT2... | | | CHIP SEQUENCE PERIOD | |
| | PDC | TRIGGER OUT1 POL | | | POS | NEG |
| | GSM/EDGE | TRIGGER OUT2 POL | | | POS | NEG |
| | DECT | TRIGGER OUT1 DELAY | | | 0 | Chip |
| | | TRIGGER OUT2 DELAY | | | 0 | Chip |

Select MS 1

FREQ **1.920 000 000 0** GHz LEVEL **-10.0** dBm

ALC-ON

| | | | | | |
|--|------------|-----------------|------|------|-------------------|
| FREQUENCY LEVEL ANALOG MOD VECTOR MOD DIGITAL MOD DIGITAL STD ARB MOD NOISE/DIST FADING SIM BERT LF OUTPUT | PHS | COPY BS/MS... | | | ARMED_AUTO |
| | IS95 | TRIGGER MODE... | | | |
| | WCDMA | TRIGGER... | | | EXT |
| | WCDMA/3GPP | CLOCK... | | | INT |
| | NADC | EXT INPUTS... | | | 1kΩ/GND |
| | PDC | TOTAL POWER | | | 0.0 dB |
| | GSM/EDGE | SELECT BS/MS | | | |
| | DECT | | | | |
| | | MS 1 | MS 2 | MS 3 | MS 4 |
| | | OFF | OFF | OFF | OFF |

FREQ 1.920 000 000 0 GHz LEVEL -10.0 dBm

ALC-ON

MS 1 STATE OFF ON

MS MODE... DPCCH+DPDCH

SCRAMBLING CODE MODE... LONG

SCRAMBLING CODE 00 0000 H

TPC... PATT

TPC PATTERN 0 Bin

TPC PATTERN/DLIST READ OUT MODE... CONTINUOUS

DPDCH Settings

POWER 0.0 dB

DL-UL TIMING OFFSET 1024 Chip

TFCI STATE OFF ON

Switch on MS1 State

IEC/IEEE bus command:

: SOUR: W3GP: MST1: STAT ON

FREQ 1.920 000 000 0 GHz LEVEL -10.0 dBm

ALC-ON

MS 1 STATE OFF ON

MS MODE... DPCCH+DPDCH

SCRAMBLING CODE MODE... LONG

SCRAMBLING CODE 00 0000 H

TPC... PATT

TPC PATTERN 0 Bin

TPC PATTERN/DLIST READ OUT MODE... CONTINUOUS

DPDCH Settings

POWER 0.0 dB

DL-UL TIMING OFFSET 1024 Chip

TFCI STATE OFF ON

Set TFCI State ON

IEC/IEEE bus command:

: SOUR: W3GP: MST1: DPCC: TFCI: STAT ON

4.5.3 Channel-specific settings

In this step we set parameters in the ENHANCED CHANNELS menu of MS 1 (type of RMC, data)

FREQ 1.920 000 000 0 GHz LEVEL -10.0 dBm

ALC-ON

MISUSE TPC FOR OUTPUT POWER CTRL OFF ON

TPC POWER STEP 0.0 dB

DPDCH Settings

ENHANCED CHANNELS... OFF

OVERALL SYMBOL RATE... 30 kSPS

POWER PER DPDCH 0.0 dB

| CHANNEL NUMBER | 1 | 2 | 3 | 4 | 5 | 6 |
|----------------|-------|---|---|---|---|---|
| TYPE | DPDCH | | | | | |
| SYMBOL RATE | 30 | | | | | |
| CHAN CODE | 32 | | | | | |

In the MS 1 menu select ENHANCED CHANNELS...

FREQ 1.920 000 000 0 GHz LEVEL -10.0 dBm

ALC-ON

ENHANCED CHANNELS STATE OFF ON

Channel Codings

CHANNEL CODING STATE OFF ON

CODING TYPE... MEASURE 12.2

INTERLEAVER 1 OFF ON

INTERLEAVER 2 OFF ON

DPDCH Bit Error Insertion

INSERT BIT ERRORS IN DATA OFF ON

NOMINAL BIT ERROR RATE 1.000 E-03

RESULTING BIT ERROR RATE DPDCH 0.000 E-03

External Power Control

Switch on ENHANCED CHANNELS STATE

IEC/IEEE bus command:

: SOUR: W3GP: MST: ENH: STAT ON

3GPP BS Tests with SMIQ

| | | | |
|--------------------------------|---------------------|--------------|-----------|
| FREQ | 1.920 000 000 0 GHz | LEVEL | -10.0 dBm |
| ALC-ON | | | |
| ENHANCED CHANNELS STATE | | MEASURE 12.2 | |
| Channel Coding | | MEASURE 64 | |
| CHANNEL CODING STATE | | MEASURE 144 | |
| CODING TYPE... | | MEASURE 384 | |
| INTERLEAVER 1 | | AMR_CODER | |
| INTERLEAVER 2 | | | |
| Bit Error Insertion | | | |
| INSERT BIT ERRORS IN DATA | | | |
| NOMINAL BIT ERROR RATE | | | |
| RESULTING BIT ERROR RATE DPDCH | | | |
| External Power Control | | | |

Switch on CHANNEL CODING STATE and set CODING TYPE... to the desired Reference Measurement Channel

For Receiver Characteristics, set CODING TYPE to MEASURE 12.2.

For Performance Requirements, set CODING TYPE to MEASURE 12.2, 64, 144 or 384

IEC/IEEE bus commands:

```
: SOUR: W3GP: MST: ENH: CCOD:
STAT ON
```

```
: SOUR: W3GP: MST: ENH: CCOD:
TYPE n
n = M12K2, M64K, M144K or
M384K
```

| | | | |
|-------------------------------------|---------------------|------------------------|-----------|
| FREQ | 1.920 000 000 0 GHz | LEVEL | -10.0 dBm |
| ALC-ON | | | |
| POWER STEP | | 1.00 dB | |
| POWER UP RANGE | | 10.0 dB | |
| POWER DOWN RANGE | | 10.0 dB | |
| Common Enhanced Channels Settings | | | |
| SEQUENCE LENGTH | | CURRENT MAX: 145 Frame | |
| OVERALL SYMBOL RATE... | | 2 Frame | |
| ENHANCED DPCCH STATE | | 60 ksp/s | |
| Specific Enhanced Channels Settings | | | |
| CHANNEL NUMBER | 1 E | 2 E | 3 E |
| TYPE | DPDCH | | |
| SYMBOL RATE | 60 | | |

Set the **sequence length** in units of W-CDMA frames:

For Receiver Characteristics (BER test), set SEQUENCE LENGTH to 1022.

For Performance Requirements (BLER test), set SEQUENCE LENGTH to 1020 or 1024.

IEC/IEEE bus command:

```
: SOUR: W3GP: MST: ENH: SLEN n
```

| | | | |
|-----------------------------------|---------------------|------------------------|-----------|
| FREQ | 1.920 000 000 0 GHz | LEVEL | -10.0 dBm |
| ALC-ON | | | |
| External Power Control | | | |
| EXTERNAL POWER CONTROL STATE | | OFF ON | |
| POWER STEP | | 1.00 dB | |
| POWER UP RANGE | | 10.0 dB | |
| POWER DOWN RANGE | | 10.0 dB | |
| Common Enhanced Channels Settings | | | |
| SEQUENCE LENGTH DPDCH | | CURRENT MAX: 168 Frame | |
| OVERALL SYMBOL RATE... | | 60 ksp/s | |
| POWER DPDCH | | 0.0 dB | |
| ENHANCED DPCCH STATE | | OFF ON | |
| POWER DPCCH | | -2.69 dB | |

Set the correct **power ratio of DPCCH/DPDCH**:

For example, set POWER DPCCH to -2.69 dB for a 12.2 kbps RMC; leave POWER DPDCH at 0 dB

IEC/IEEE bus command:

```
: SOUR: W3GP: MST: ENH: POW:
DPCCH -2.69
```

| | | | |
|------------------------------|---------------------|--------------------|-----------|
| FREQ | 1.920 000 000 0 GHz | LEVEL | -10.0 dBm |
| ALC-ON | | | |
| CHANNEL NUMBER | 1 E | 2 E | 3 E |
| TYPE | DPDCH | | |
| SYMBOL RATE | 60 | | |
| CHAN CODE | 16 | | |
| DATA DTCH | PN9 | | |
| DATA DCCH | PN9 | | |
| CHANGE DATA | | | |
| SELECT DATA LIST... | | CURRENT: BLUETOOTH | |
| COPY CURRENT DATA LIST TO... | | | |

Select PN9 as data for DTCH and DCCH

IEC/IEEE bus commands:

```
: SOUR: W3GP: MST: ENH: CHAN1:
DTCH PN9
```

```
: SOUR: W3GP: MST: ENH: CHAN1:
DCCH PN9
```

Additional hints:

- The maximum number of frames is indicated by CURRENT MAX, if W-CDMA/3GPP has been activated at least once after the instrument was switched on. To ensure that this feature is available, calculate a simple signal as described in section 4.6.

- The Enhanced Channels use the same memory as the data lists stored in SMIQ. Delete some data lists if the maximum number of frames is not sufficient (see section 4.3).
- Keep ENHANCED DPCC STATE off. This function is not required for BS receiver tests. With this function active, the sequence length of 1022 frames would not be possible. The function is only required if Enhanced Channels are used for the output power dynamics test (section 5.1).
- The sequence length of 1022 frames is for performing BER tests with non-truncated PRBS 9. For BLER tests only the CRC is analyzed, not the user data. For BLER on DTCH the number of frames has to be even, so 1022 frames is also correct. For BLER on DCCH, the number of frames has to be a multiple of four, so choose 1020 or 1024 frames.

4.5.4 Inserting bit errors or block errors

Use this function to verify the BS internal BER or BLER calculation (see 6.8 and 7.6). These settings are not required for other tests.

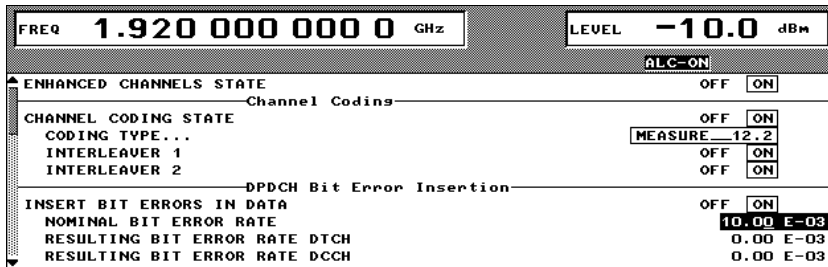

Inserting bit errors: In the Enhanced Channels menu switch on INSERT BIT ERRORS IN DATA and set NOMINAL BIT ERROR RATE

IEC/IEEE bus commands:

```
: SOUR:W3GP:MST:ENH:DERR:
BIT:STAT ON
```

```
: SOUR:W3GP:MST:ENH:DERR:
BIT:RATE n
for example n = 10E-3
```

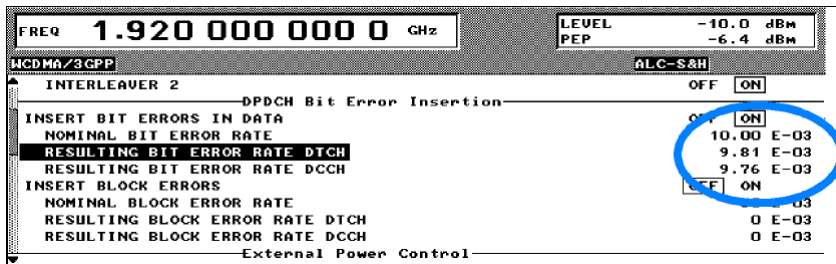

After calculation (see 4.5.5), SMIQ indicates the resulting bit error rates

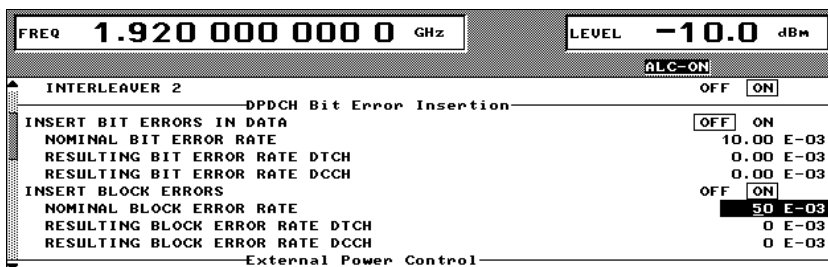

Inserting block errors: In the Enhanced Channels menu switch on INSERT BLOCK ERRORS and set NOMINAL BLOCK ERROR RATE

IEC/IEEE bus commands:

```
: SOUR:W3GP:MST:ENH:DERR:
BLOC:STAT ON
```

```
: SOUR:W3GP:MST:ENH:DERR:
BLOC:RATE n
for example n = 50E-3
```

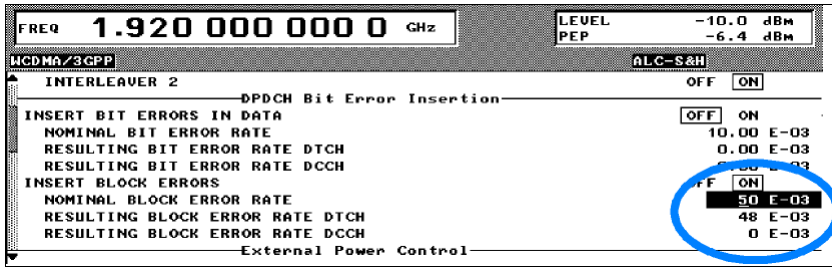

After calculation (see 4.5.5) of the 3GPP signal, SMIQ indicates the resulting block error rates

Additional hint:

- For some combinations of sequence length and coding type (or symbol rate), it might be impossible to match the nominal bit error rate or block error rate exactly. Therefore, the resulting BER or BLER is displayed after calculation.

4.5.5 Completing the settings

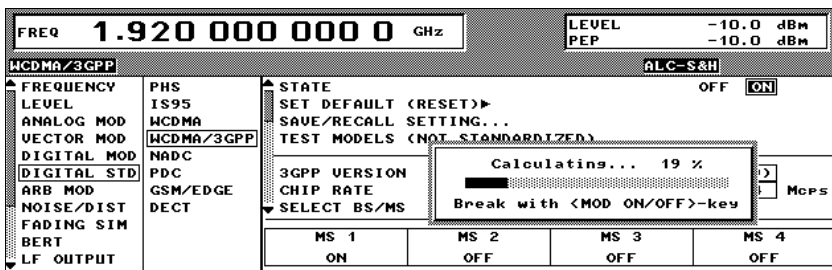

Return to the WCDMA/3GPP menu and switch on STATE

SMIQ now calculates the 3GPP signal and indicates the calculation with a progress bar.

IEC/IEEE bus command:

:SOUR:W3GP:STAT ON

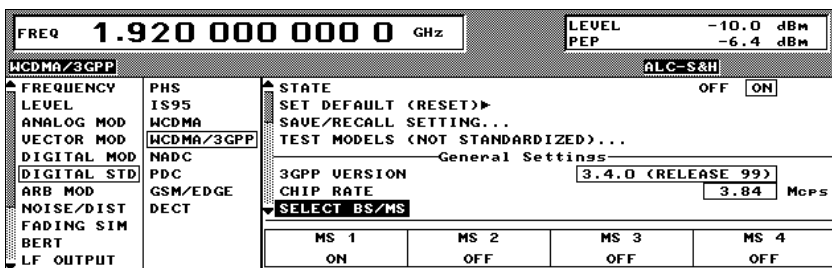

SMIQ is waiting for the trigger signal from the BS. After the trigger pulse, SMIQ will start to output the uplink RMC.

Additional hints:

- If you change 3GPP settings while the WCDMA/3GPP STATE is ON, the 3GPP system will be switched off (so that only a CW signal is present), until you set the WCDMA/3GPP STATE to ON once again or press the MOD ON/OFF key on the front panel of SMIQ. Try to avoid changing 3GPP settings during the tests, as recalculation might be very time-consuming.
- Calculated signals that include Enhanced Channels can be stored on an external PC and reloaded using the application software *SetupAccelerator*. Such a reload procedure is much faster than recalculating the signal. The *SetupAccelerator* software is provided with the Rohde & Schwarz Application Note 1GP44 [4] and is available on the Rohde & Schwarz website: <http://www.rohde-schwarz.com>.

The following parameters can be changed without switching off the 3GPP signal:

- TRIGGER SOURCE. The trigger source can be switched from EXT to INT and vice versa.
- TRIGGER MODE: A 3GPP signal can be halted by switching TRIGGER MODE to ARMED AUTO or ARMED RETRIG.
- The 10 MHz reference can be switched to EXT or INT (make sure that an external reference signal is present if you switch to EXT).

4.6 Generating a W-CDMA interfering signal

The signals generated in this section can be used as W-CDMA interferers in the Receiver Characteristics tests (see section 6).

4.6.1 Predefined uplink signals

The most convenient way to get a W-CDMA interfering signal is to use the predefined settings functions of SMIQ.

| | | | |
|-------------|---------------------|------------------------|--------------------|
| FREQ | 1.920 000 000 0 GHz | LEVEL | -10.0 dBm |
| ALC-ON | | | |
| FREQUENCY | PHS | STATE | |
| LEVEL | IS95 | SET DEFAULT (RESET) | |
| ANALOG MOD | WCDMA | SAVE/RECALL SETTING... | |
| VECTOR MOD | WCDMA/3GPP | TEST MODELS... | |
| DIGITAL MOD | NADC | General Settings | |
| ARB MOD | PDC | 3GPP VERSION | 3.2.0 (RELEASE 99) |
| NOISE/DIST | GSM/EDGE | CHIP RATE | 3.84 Mcps |
| FADING SIM | DECT | SELECT BS/MS | |
| AMIQ CTRL | | BS 1 | BS 2 |
| BERT | | BS 3 | BS 4 |
| | | OFF | OFF |
| | | OFF | OFF |

Select menu DIGITAL STANDARD → WCDMA 3GPP

Do not set the W-CDMA STATE to on before you have done all necessary settings.

First reset the W-CDMA setup to make sure that no unwanted channel is active:

Choose SET DEFAULT (RESET) in the WCDMA/3GPP menu

IEC/IEEE bus command:

: SOUR:W3GP: PRES

| | | | |
|-------------|---------------------|------------------|-------------------------|
| FREQ | 1.920 000 000 0 GHz | LEVEL | -10.0 dBm |
| ALC-ON | | | |
| FREQUENCY | PHS | General Settings | |
| LEVEL | IS95 | 3GPP VERSION | 3.4.0 (RELEASE 99) |
| ANALOG MOD | WCDMA | CHIP RATE | 3.84 Mcps |
| VECTOR MOD | WCDMA/3GPP | LINK DIRECTION | DOWN/FORWARD UP/REVERSE |
| DIGITAL MOD | NADC | SEQUENCE LENGTH | 1 Frame |
| ARB MOD | PDC | CLIPPING LEVEL | 100 % |
| NOISE/DIST | GSM/EDGE | FILTER... | WCDMA 0.22 |
| FADING SIM | DECT | SELECT BS/MS | |
| AMIQ CTRL | | MS 1 | MS 2 |
| BERT | | MS 3 | MS 4 |
| | | OFF | OFF |
| | | OFF | OFF |

Set link direction to UP/REVERSE

IEC/IEEE bus command:

: SOUR:W3GP: LINK REV

3GPP BS Tests with SMIQ

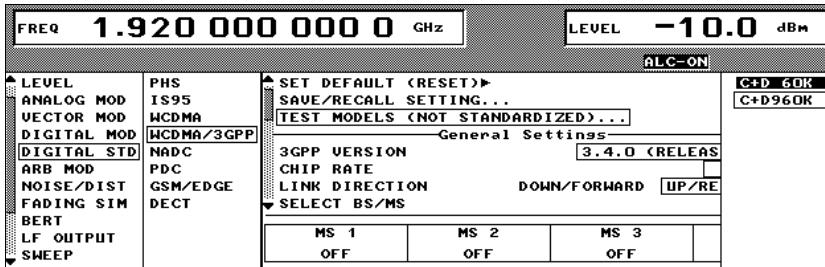

Select TEST MODELS (NOT STANDARDIZED)... and choose the desired value. SMIQ offers two predefined uplink settings, DPCCH + 1 DPDCH (60 kbps) or DPCCH + 1 DPDCH (960 kbps)

IEC/IEEE bus command:

```
: SOUR: W3GP: SETT: TMODE: MST
' C+D 60K'
```

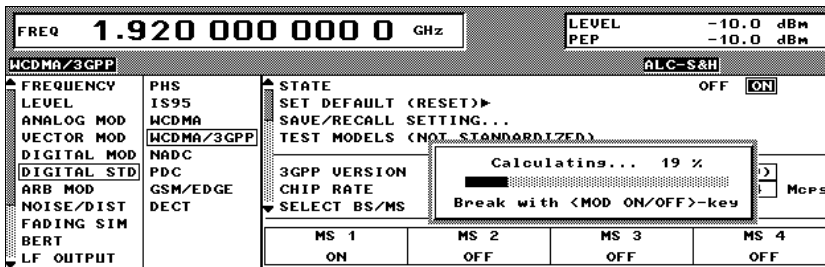

Return to the WCDMA/3GPP menu and switch on STATE

SMIQ now starts calculating the 3GPP signal and indicates the calculation with a progress bar.

IEC/IEEE bus command:

```
: SOUR: W3GP: STAT ON
```

Additional hints:

- As the BS does not evaluate the interfering signals, it is not necessary to start the signal generation synchronous with the BS. However, if the signal is triggered externally, the trigger mode must be set as described in 4.4.1.
- SMIQ can display the constellation diagram or CCDF of the signal (see 4.7).

4.6.2 Other uplink signals

To generate other signals than the predefined ones, proceed as follows.

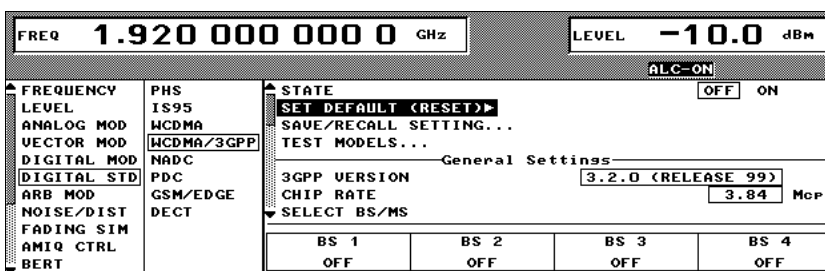

Select menu DIGITAL STANDARD → WCDMA/3GPP

Do not set the W-CDMA STATE to ON before you have done all necessary settings.

First reset the W-CDMA setup to make sure that no unwanted channel is active:

Choose SET DEFAULT (RESET) in the WCDMA/3GPP menu

IEC/IEEE bus command:

```
: SOUR: W3GP: PRES
```

3GPP BS Tests with SMIQ

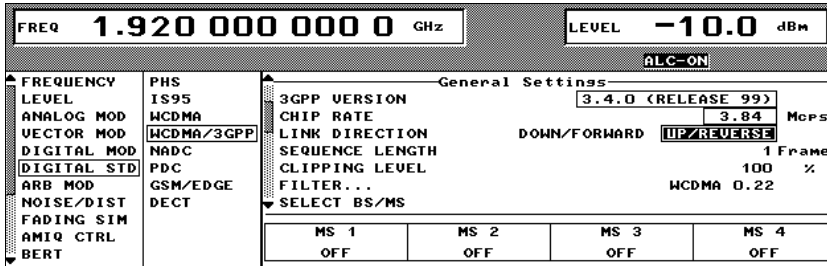

Set link direction to UP/REVERSE

IEC/IEEE bus command:
:SOUR:W3GP:LINK REV

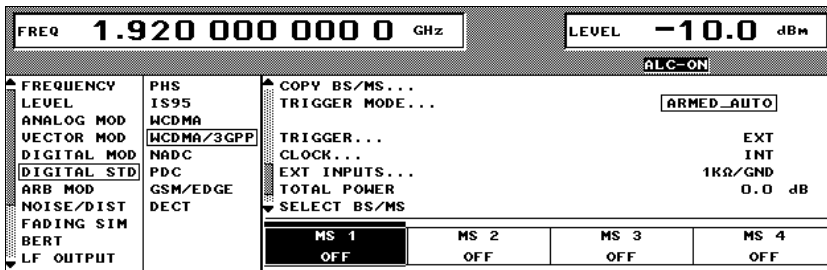

Select MS 1

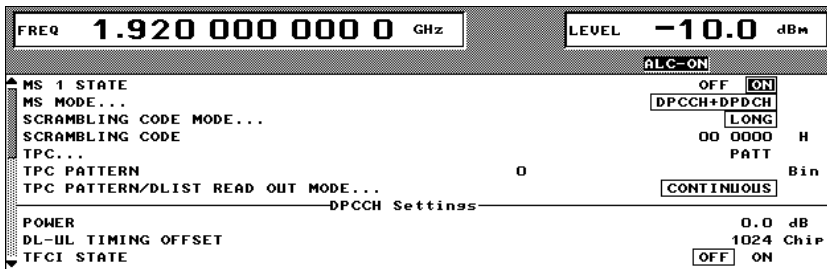

Switch on MS1 State

IEC/IEEE bus command:
:SOUR:W3GP:MST1:STAT ON

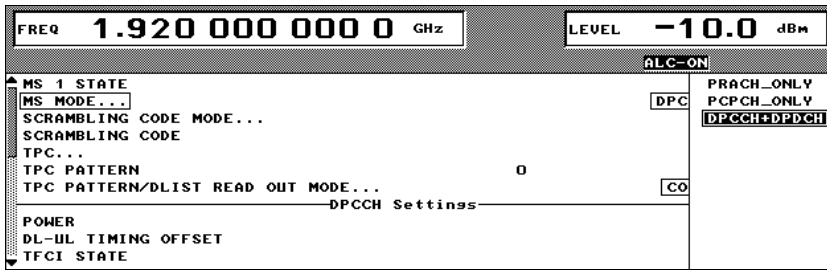

Select the desired MS MODE:

PRACH_ONLY, PCPCH_ONLY or DPCCH+DPDCH are available.

In this example we choose DPCCH+DPDCH

IEC/IEEE bus command:
:SOUR:W3GP:MST1:MODE
DPCDCH

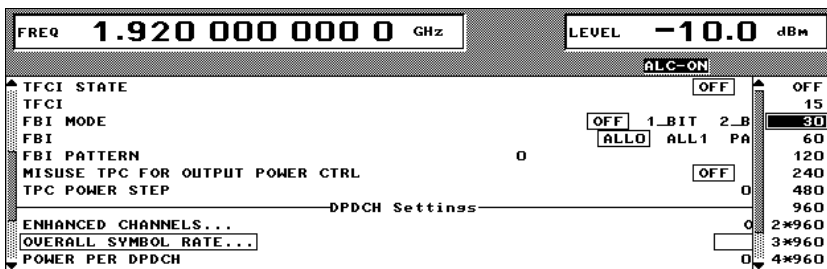

Select the desired OVERALL SYMBOL RATE

IEC/IEEE bus command:

:SOUR:W3GP:MST1:DPDC:ORAT
n

n = D15K, D30K, D60K,
D120K, D240K, D480K,
D960K, X2, X3, X4, X5, X6

3GPP BS Tests with SMIQ

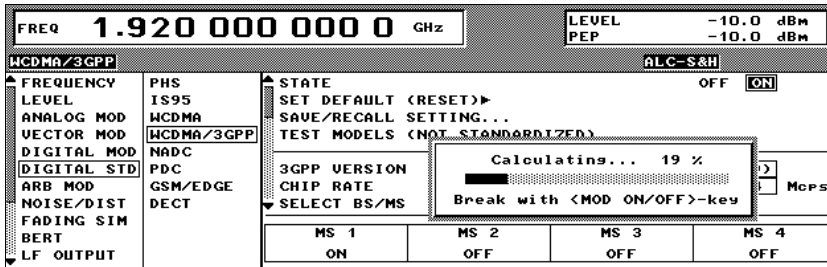

Return to the WCDMA/3GPP menu and switch on STATE

SMIQ now starts calculating the 3GPP signal and indicates the calculation with a progress bar.

IEC/IEEE bus command:

```
: SOUR: W3GP: STAT ON
```

Additional hints:

- As the BS does not evaluate the interfering signals, it is not necessary to start the signal generation synchronous with the BS. However, if the signal is triggered externally, the trigger mode must be set as described in 4.4.1.
- SMIQ can display the constellation diagram or CCDF of the signal (see 4.7).

4.6.3 Downlink signal with one DPCH only

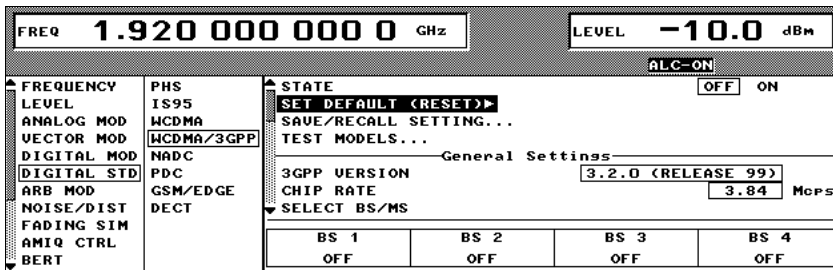

Select menu DIGITAL STANDARD → WCDMA/3GPP

Do not set the W-CDMA STATE to ON before you have done all necessary settings.

First reset the W-CDMA setup to make sure that no unwanted channel is active:

Choose SET DEFAULT (RESET) in the WCDMA/3GPP menu

IEC/IEEE bus command:

```
: SOUR: W3GP: PRES
```

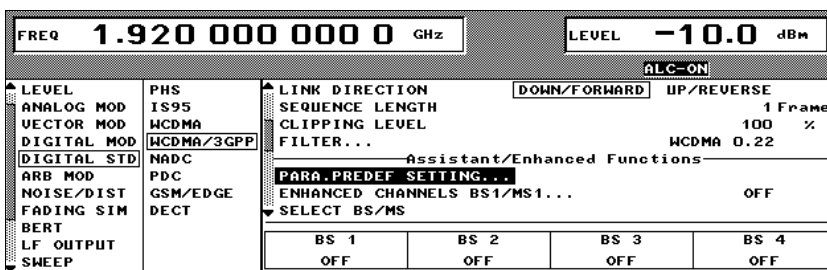

Select PARA.PREDEF SETTINGS...

3GPP BS Tests with SMIQ

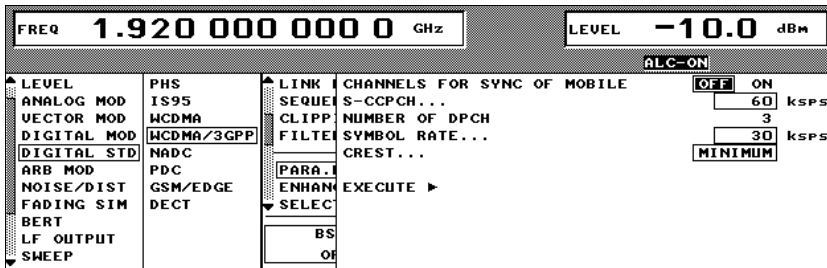

Switch off CHANNELS FOR SYNC OF MOBILE

IEC/IEEE bus command:

: SOUR:W3GP:PPAR: SCH OFF

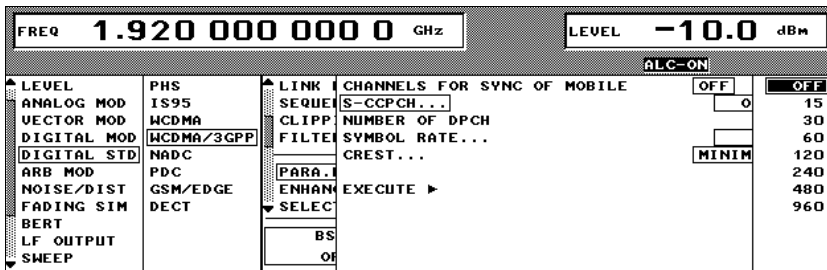

Switch off S-CCPCH...

IEC/IEEE bus command:

: SOUR:W3GP:PPAR: SCCPCH: STAT OFF

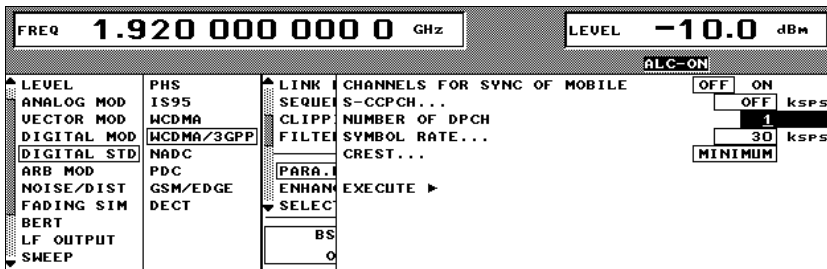

Set NUMBER OF DPCH to 1

IEC/IEEE bus command:

: SOUR:W3GP:PPAR: DPCH: COUN 1

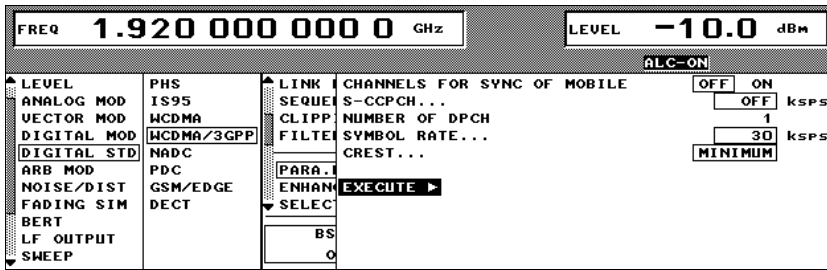

Select EXECUTE ►

The PARA PREDEF submenu closes.

IEC/IEEE bus command:

: SOUR:W3GP:PPAR: EXEC

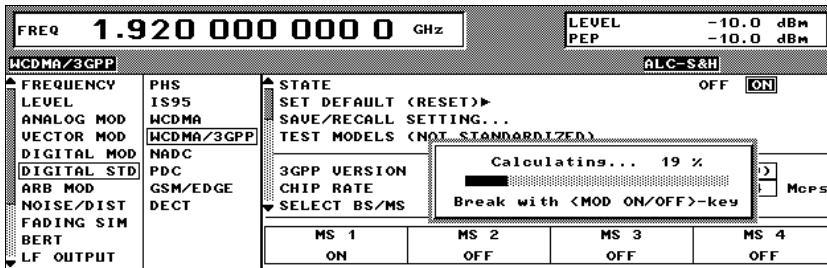

In the main menu of WCDMA/3GPP switch on STATE

SMIQ now starts calculating the 3GPP signal and indicates the calculation with a progress bar.

IEC/IEEE bus command:

: SOUR:W3GP:STAT ON

4.7 Graphical representation of 3GPP signals

FREQ 1.920 000 000 0 GHz LEVEL -10.0 dBm
PEP -6.4 dBm

WCDMA/3GPP ALC-S&H

FREQUENCY PHS IS95
LEVEL IS95
ANALOG MOD WCDMA
VECTOR MOD WCDMA/3GPP
DIGITAL MOD NADC
DIGITAL STD PDC
ARB MOD GSM/EDGE
NOISE/DIST DECT

ADDITIONAL MS BASED ON MS4... OFF
Graphics

CCDF ►
CCDF TRACES 3
CONSTELLATION ►

COPY BS/MS...
SELECT BS/MS

| | | | |
|------|------|------|------|
| MS 1 | MS 2 | MS 3 | MS 4 |
| ON | OFF | OFF | OFF |

To display the CCDF of a calculated 3GPP signal, select CCDF ► in the WCDMA/3GPP menu.

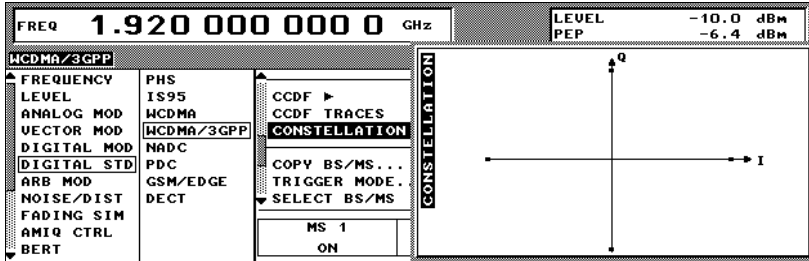
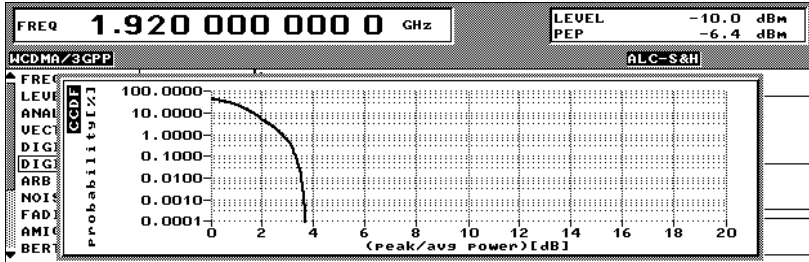

Furthermore, the constellation diagram can be displayed

FREQ 1.920 000 000 0 GHz LEVEL -10.0 dBm
PEP +0.6 dBm

WCDMA/3GPP ALC-S&H

FREQUENCY PHS IS95
LEVEL IS95
ANALOG MOD WCDMA
VECTOR MOD WCDMA/3GPP
DIGITAL MOD NADC
DIGITAL STD PDC
ARB MOD GSM/EDGE
NOISE/DIST DECT

STATE OFF
SET DEFAULT (RESET)►
SAVE/RECALL SETTING...
TEST MODELS...

General Settings

3GPP VERSION 3.4.0 (RELEASE 99)
CHIP RATE 3.84 Mcps

SELECT BS/MS

| | | | |
|------|------|------|------|
| BS 1 | BS 2 | BS 3 | BS 4 |
| ON | OFF | OFF | OFF |

For downlink signals, the code domain per BS can be displayed:

In the WCDMA/3GPP menu select a BS

FREQ 1.920 000 000 0 GHz LEVEL -10.0 dBm
PEP +0.6 dBm

WCDMA/3GPP ALC-S&H

TRANSMIT DIVERSITY OFF ANTENNA_1 ANTENNA_2
NUMBER OF PAGE INDICATORS PER FRAME... 18
MULTI CHANNEL EDIT...
ENHANCED CHANNELS... OFF

CODE DOMAIN (Hardkey: STATUS) ►

CHANNEL GRAPH ►

| CHNO | TYPE | SYM.RATE | CH.COD | POW/DB | DATA | TOFFS | PILOT | TPC | MC | STATE |
|------|---------|----------|--------|--------|------|-------|-------|-----|----|-------|
| 0 | P-CPICH | 15 | 0 | -10.0 | | | | | | ON |
| 1 | S-CPICH | 15 | 0 | 0.0 | | | | | | OFF |
| 2 | P-SCH | 15 | -13.0 | | | | | | | ON |
| 3 | S-SCH | 15 | -13.0 | | | | | | | ON |

In the BS submenu select CODE DOMAIN ► or press the STATUS key on the SMIQ front panel

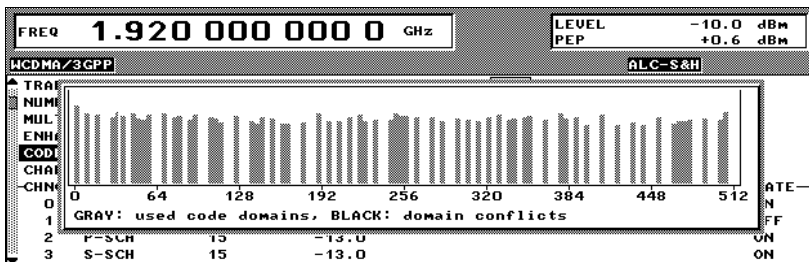

5 Transmitter Characteristics to 3GPP TS25.141

To test the Transmitter Characteristics an FSIQ Signal Analyzer is also required. See references [3] and [8] for more detailed information.

5.1 Output power dynamics

5.1.1 Test purpose and conditions

3GPP uses a closed loop power control method called "inner loop power control". The main feature of this method is that one device in a connection (for example a mobile) controls the output power of its counterpart (in this example the power of the dedicated channel that the base station transmits to the mobile) In downlink, the BS transmitter adjusts the output power of a code channel according to the Transmit Power Control (TPC) bits received from the corresponding uplink signal. A zero means "power down", a one "power up". The power step per bit is defined.

These tests require an FSIQ signal analyzer for the code domain power analysis and an SMIQ to simulate an uplink stimulus for the BS.

For "Power Control Steps" the BS sends a 3GPP Test Model 2 signal and reacts to TPC commands transmitted by SMIQ. The output power of the downlink code channel under test is measured by FSIQ. There are two test scenarios:

- In scenario 1, SMIQ transmits alternating TPC bits, i.e. a 01 pattern. The accuracy of a 1dB power step must be ≤ 0.5 dB, for a 0.5 dB power step ≤ 0.25 dB.
- In scenario 2, SMIQ transmits 10 consecutive zeros or ones. The accuracy of 10 consecutive 1 dB steps must be ≤ 2 dB, for 10 consecutive 0.5 dB steps ≤ 1 dB.

For "Power Control Dynamic Range" the BS also sends a 3GPP Test Model 2 signal. The DPCH under test outputs 3dB less than the maximum possible power. Then SMIQ transmits consecutive zeros to drive the DPCH under test to the minimum level. The minimum level shall be less than $P_{max} - 28$ dB.

5.1.2 Test setup

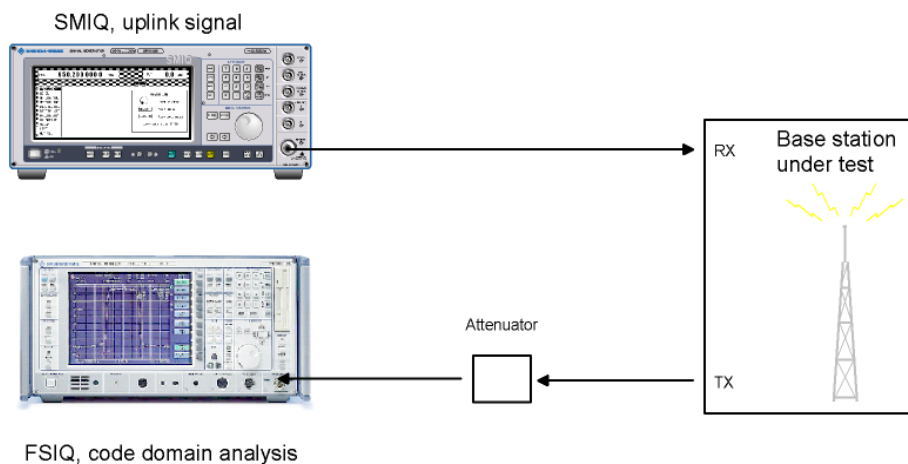
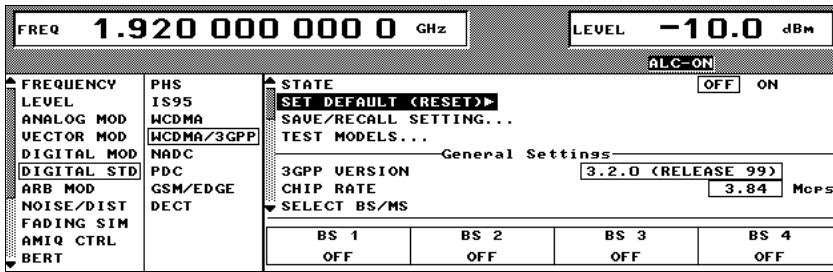

Fig. 5.1: Test setup for output power dynamics. SMIQ transmits uplink signals to stimulate BS inner loop power control. The accuracy of the power control mechanism is measured with the code domain analyzer in FSIQ.

5.1.3 Setting TPC bits in the uplink signal



Select menu DIGITAL STANDARD
 → WCDMA/3GPP

Do not set the W-CDMA STATE to on before you have done all necessary settings.

First reset the W-CDMA setup to make sure that no unwanted channel is active:

Choose SET DEFAULT (RESET) in the WCDMA/3GPP menu

IEC/IEEE bus command:

: SOUR:W3GP: PRES

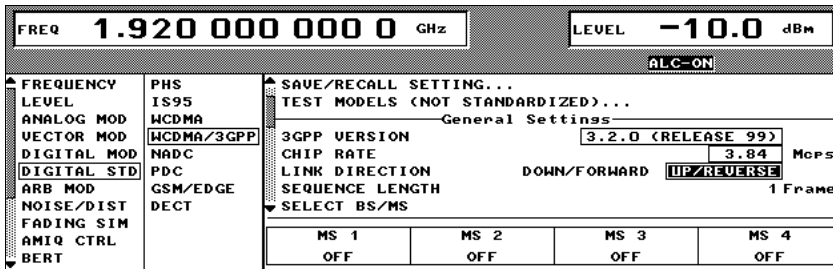

Set link direction to UP/REVERSE

IEC/IEEE bus command:

: SOUR:W3GP: LINK REV

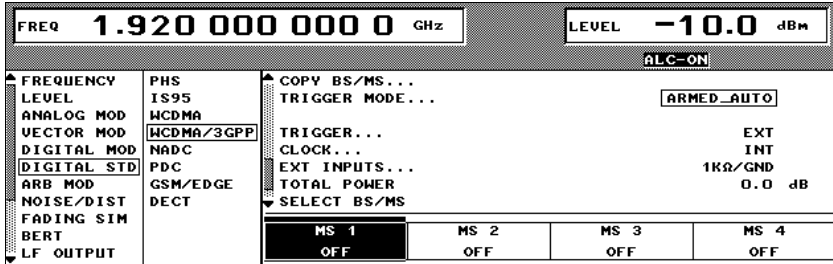

Select MS 1

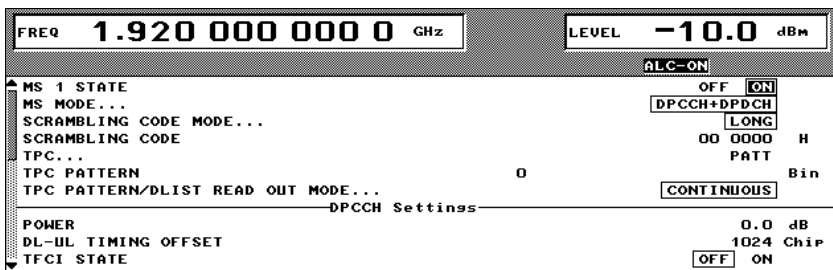

Switch on MS1 State

IEC/IEEE bus command:

: SOUR:W3GP:MST1:STAT ON

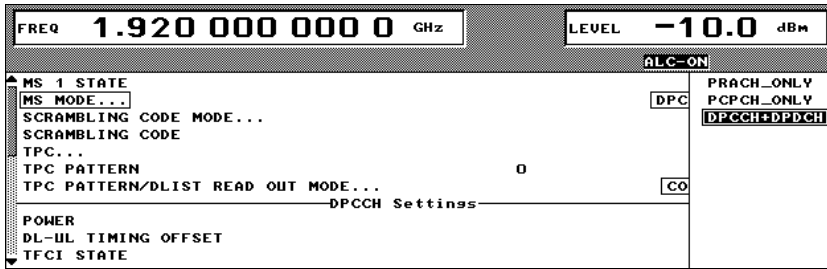

Select the desired MS MODE:
PRACH_ONLY, PCPCH_ONLY or DPCCH+DPDCH are available.

In this example we choose DPCCH+DPDCH

IEC/IEEE bus command:

```
:SOUR:W3GP:MST1:MODE  
DPCDCH
```

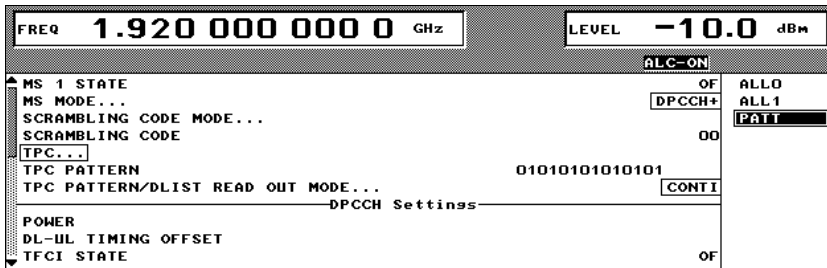

Set the TPC to the desired mode:
ALL0, ALL1 or PATT

IEC/IEEE bus command:

```
:SOUR:W3GP:MST1:TPC:DATA n  
n = ZERO, ONE, PATT
```

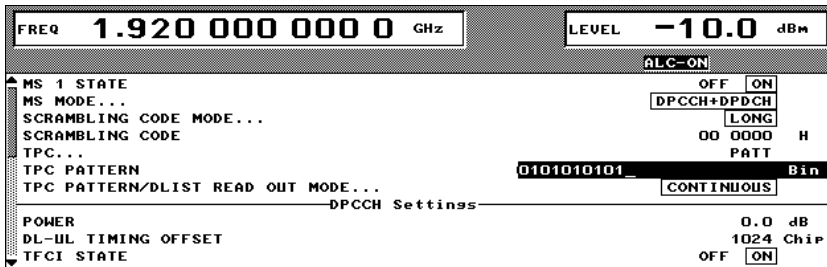

If PATT has been selected, enter the desired bit pattern

IEC/IEEE bus command:

```
:SOUR:W3GP:MST1:TPC:PATT  
n, m
```

n can be a binary, octal or hexadecimal number, m is the number of bits to be used

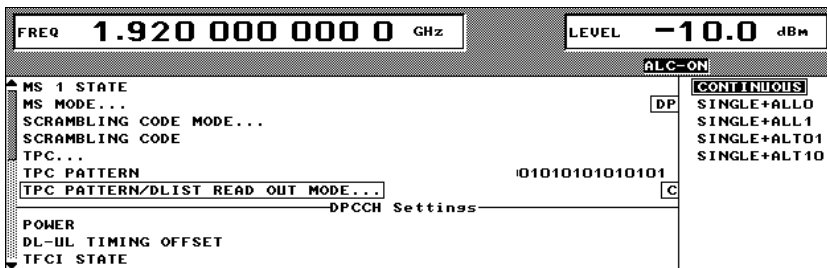

Set the TPC read out mode to the desired value:

IEC/IEEE bus command:

```
:SOUR:W3GP:MST1:TPC:READ n  
n = CONT, S0A, S1A, S01A, S10A
```

The possible read out modes are:

- CONTINUOUS (CONT): the TPC pattern is continuously repeated.
- SINGLE+ALL0 (S0A): the pattern is transmitted once, followed by consecutive zeros
- SINGLE+ALL1 (S1A): the pattern is transmitted once, followed by consecutive ones
- SINGLE+ALT01 (S01A): the pattern is transmitted once, followed by alternating zeros and ones
- SINGLE+ALT10 (S10A): the pattern is transmitted once, followed by alternating ones and zeros

Note: These sequences are only valid for the duration of the calculated 3GPP signal. For example, if the 3GPP signal is 13 frames long, the mode SINGLE+ALL0 transmits the TPC pattern once and then zeros for the rest of the 13 frames. After 13 frames, the entire 3GPP signal is repeated, including the TPC sequence! This repetition period can be extended beyond 13 frames if Enhanced Channels are used (see section 4.5).

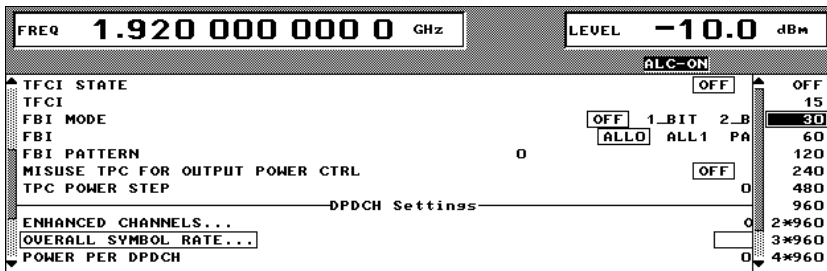

Select the desired OVERALL SYMBOL RATE

IEC/IEEE bus command:

: SOUR:W3GP:MST1:DPDC:ORAT n

n = D15K, D30K, D60K, D120K, D240K, D480K, D960K, X2, X3, X4, X5, X6

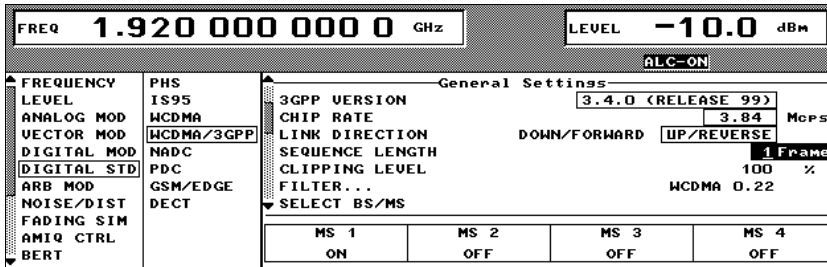

Return to the main menu of WCDMA/3GPP and select the appropriate sequence length

IEC/IEEE bus command:

: SOUR:W3GP:SLEN n

n = 1 .. 13

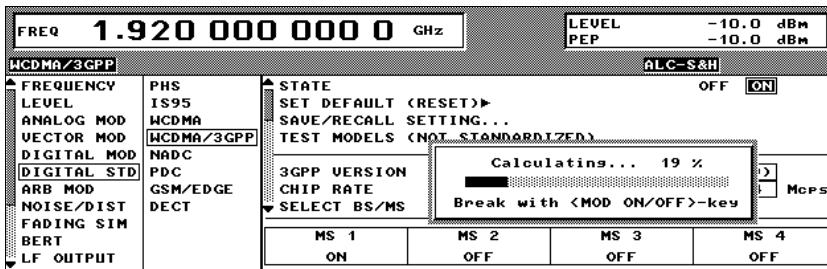

Switch on STATE

SMIQ now starts calculating the 3GPP signal and indicates the calculation with a progress bar.

IEC/IEEE bus command:

: SOUR:W3GP:STAT ON

- For power control steps scenario 1 select PATT and enter "01" as bit pattern. Set read out mode to CONTINUOUS. Set the sequence length to 2 frames or another even number ≤ 13 (maximum number of frames without using Enhanced Channels). This ensures an even number of slots so that the 01 pattern is not truncated.
- For power control steps scenario 2 select PATT and enter 10 consecutive zeros (or ones). Select read out mode SINGLE+ALT01 or SINGLE+01. After the 10 consecutive power down (or up) steps the DPCH under test will stabilize at the final power of the 10step interval. Set the frame length to 13 (maximum value). If this is not sufficient time to perform the measurement with the analyzer, use an Enhanced Channel to extend the sequence length (the procedure to set the TPC bits is the same). With the Enhanced Channels state on, the ENHANCED DPCH mode must also be activated.
- If you use an Enhanced Channel, you can also set more complex TPC patterns by selecting a data list as TPC source.
- For power control dynamic range select ALL0 and set the read out mode to CONTINUOUS. The sequence length can be 1 to 13 frames.

Note: if continuous transmission of the uplink signal is not desired, you can stop SMIQ by setting the trigger mode back to ARMED AUTO after sending the desired TPC patterns (see also 4.4).

5.2 Transmit intermodulation

5.2.1 Test purpose and conditions

This test checks whether the transmitter generates intermodulation products of the transmitted wanted signal and interfering signals reaching the transmitter via the antenna. The transmit intermodulation level is the power of the intermodulation products when a W-CDMA modulated interference signal is injected into an antenna connector at a level lower than the wanted signal. The frequency spacing between interferer and wanted signal is 5 MHz, 10 MHz, or 15 MHz.

The interfering signal is a 3GPP Test Model 1 signal and is generated by SMIQ. The measurement is performed with an FSIQ signal analyzer. The analyzer measures spurious emissions and out of band emissions of the BS transmitter in the presence of the two signals.

5.2.2 Test setup

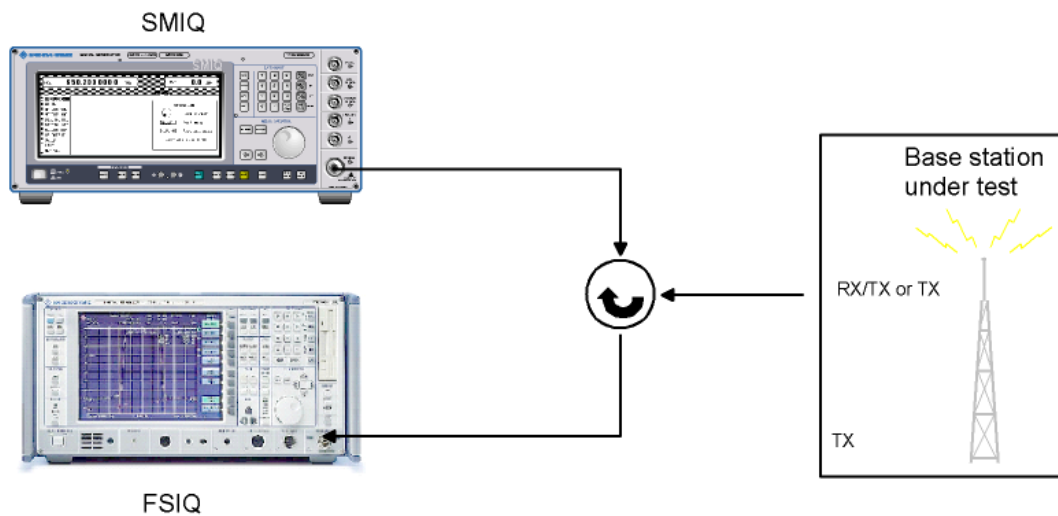
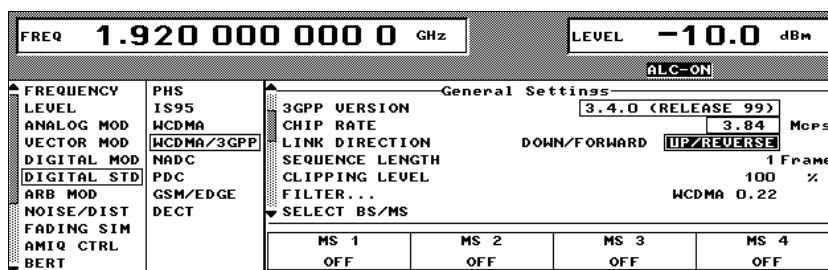

Fig. 5.2: Test setup for Transmit Intermodulation. SMIQ generates the interfering signal (3GPP Test Model 1), the wanted signal is generated by the BS. The circulator feeds the interfering signal into the BS antenna port and the resulting output signal from the BS (= wanted signal of the BS + intermodulation products) into FSIQ. FSIQ measures spurious emissions and out of band emissions of the BS transmitter in the presence of the two signals.

5.2.3 SMIQ settings for downlink Test Model 1 signal



Select menu DIGITAL STANDARD → WCDMA/3GPP

Do not set the W-CDMA STATE to on before you have done all necessary settings.

First reset the W-CDMA setup to make sure that no unwanted channel is active:

Choose SET DEFAULT (RESET) in the WCDMA/3GPP menu

IEC/IEEE bus command:

: SOUR : W3GP : PRES

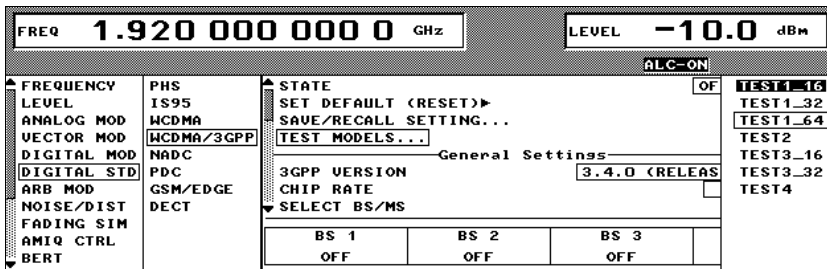

Select TEST MODELS and choose the desired value. SMIQ offers all test models defined in the standard

IEC/IEEE bus command:

```
:SOUR:W3GP:SETT:TMOD:BST 'name'
```

```
name = M1CH16, M1CH32,
M1CH64, M2, M3CH32,
M3CH64, M4
```

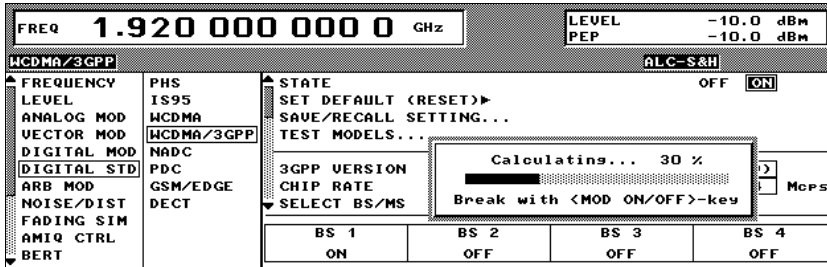

Return to the main menu of WCDMA/3GPP and switch on STATE

SMIQ now starts calculating the 3GPP signal and indicates the calculation with a progress bar.

IEC/IEEE bus command:

```
:SOUR:W3GP:STAT ON
```

Additional Hints:

- As the BS does not evaluate the interfering signals, it is not necessary to start the signal generation synchronous with the BS. However, if the signal is triggered externally, the trigger mode must be set as described in 4.4.1.
- SMIQ can indicate the constellation diagram or CCDF of the signal (see 4.7).

5.2.4 Test procedure

Set the BS to generate a 3GPP Test Model 1 signal.

Set SMIQ to transmit a Test Model 1 signal, as described above, with 30 dB less power than the BS signal and + 5 MHz offset from the BS signal.

Perform the out-of-band emissions and spurious emissions test (see reference [3] for more information).

Repeat the measurements for the other offsets (-5 MHz, ± 10 MHz, ± 15 MHz).

6 Receiver Characteristics to 3GPP TS 25.141

6.1 General remarks

The receiver tests are performed with the setup shown in Fig. 6.1.

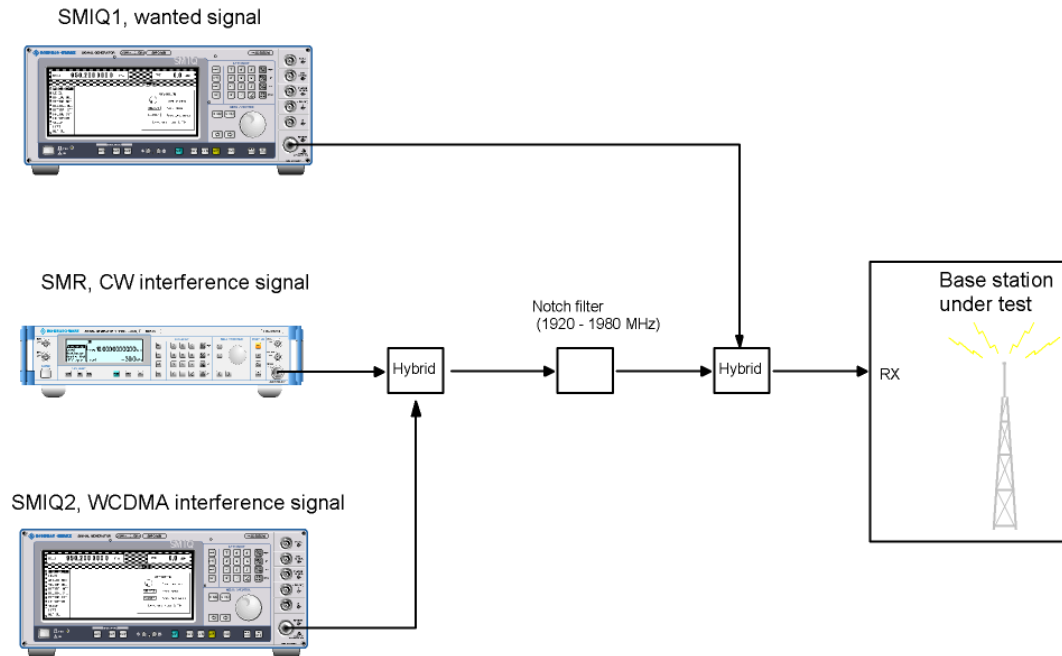

Fig. 6.1: Setup for testing base station Receiver Characteristics. SMIQ 1 generates the wanted signal, SMIQ 2 and SMR provide the various interfering signals.

The wanted signal is always a 12.2 kbps uplink RMC. Therefore it is recommended to calculate this signal once as a first step. After a single measurement has been done, stop the output of trigger signals by the BS and set SMIQ 1 back to ARMED AUTO mode. This prepares SMIQ 1 for the next measurement without recalculating the 3GPP signal.

You can use the *SetupAccelerator* software to store and reload Reference Measurement Channels in a short time. This free software is provided with application note 1GP44 [4].

All signal generators can be instructed to switch their RF signal on or off with the RF ON/OFF key or the command :OUTP:STAT ON or :OUTP:STAT OFF

6.2 Reference sensitivity level

6.2.1 Test purpose

In this test, the bit error rate at a specified (small) receiver input power is measured, to verify that the BS receiver can still handle a signal received with that low power. For a received power of -121 dBm, the BER shall not exceed 0.001. The BER is calculated from at least 300000 received data bits.

6.2.2 Test setup and generator configurations

As no interfering signal is present, only SMIQ 1 is active and transmits a 12.2 kbps uplink RMC. The active parts of SMIQ 1 are shown in the configuration figure below.

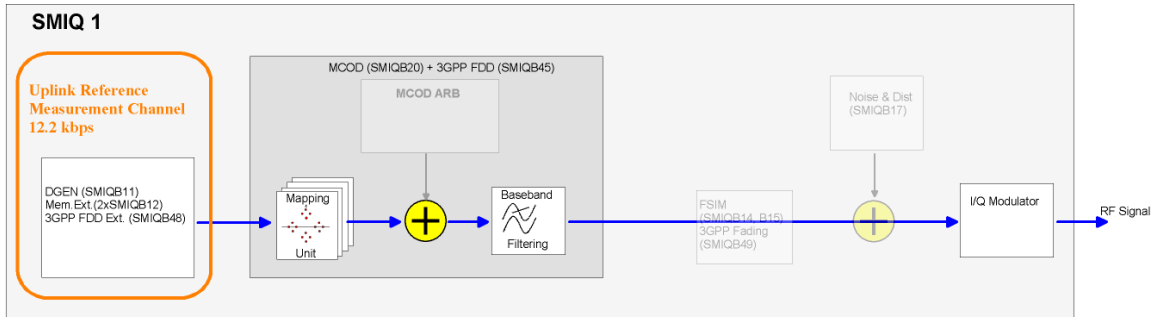

Fig. 6.2: SMIQ 1 configuration for Reference sensitivity level test. The inactive parts are shaded.

For synchronizing the BS and SMIQ 1, see section 4.4.

6.2.3 Test procedure

Set SMIQ 1 to transmit a 12.2 kbps uplink RMC and set the RF level to -121 dBm. Measure the BER from at least 30000 received data bits.

6.3 Dynamic range

6.3.1 Test purpose and conditions

This test verifies the ability of the BS to receive a test signal when interference rises in the reception frequency channel. The receiver must fulfil a specified BER requirement for a specified sensitivity degradation of the wanted signal due to AWGN in the reception channel. Thus, an AWGN signal is added to the wanted 3GPP signal (again a 12.2 kbps uplink Reference Measurement Channel). The bit error rate is measured as a function of signal-to-noise ratio.

The BER shall not exceed 0.001 for the parameters specified in Table 6.1.

Table 6.1: Parameters for dynamic range test.

| Parameter | Level | Unit |
|-------------------------|-------|----------------|
| Data rate | 12.2 | kbps |
| Wanted signal | -91 | dBm |
| Interfering AWGN signal | -73 | dBm / 3.84 MHz |

6.3.2 Test setup and generator configurations

Only SMIQ 1 is active and has to transmit a 12.2 kbps uplink Reference Measurement Channel. The AWGN signal is added inside SMIQ 1, using option SMIQB17.

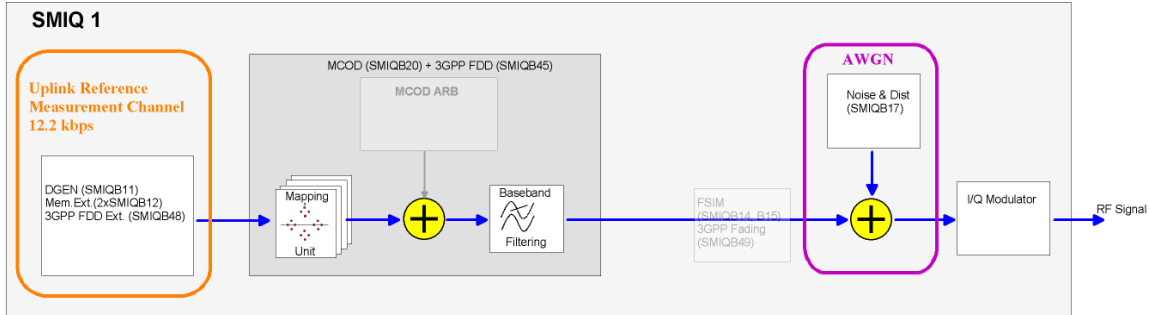

Fig. 6.3: Test setup for dynamic range measurement. SMIQ 1 generates both the wanted 3GPP signal and the AWGN. Inactive parts are shaded.

For synchronizing the BS and SMIQ 1, see section 4.4.

6.3.3 Setting the wanted 3GPP signal

Set SMIQ 1 to transmit a 12.2 kbps uplink Reference Measurement Channel, as described in 4.5.

6.3.4 Calculating the carrier-to-noise ratio

The AWGN levels stated in the 3GPP specifications are standardized to the 3.84 MHz bandwidth. On the other hand, the AWGN bandwidth shall be at least $3.84 \text{ MHz} \cdot 1.5 = 5.76 \text{ MHz}$. The carrier-to-noise ratio and the noise bandwidth are set as parameters in SMIQ. The carrier power is the value shown in SMIQ's level indicator. The noise power is the power of the noise signal in the entire bandwidth.

From Table 6.1, the interfering signal has -73 dBm in 3.84 MHz . If the noise bandwidth is chosen to be $3.84 \text{ MHz} \cdot 2 = 7.68 \text{ MHz}$, the power in the entire bandwidth is -70 dBm . Then the carrier-to-noise ratio has to be set to -21 dB .

6.3.5 Setting AWGN parameters

For the values above, SMIQ must be set as follows:

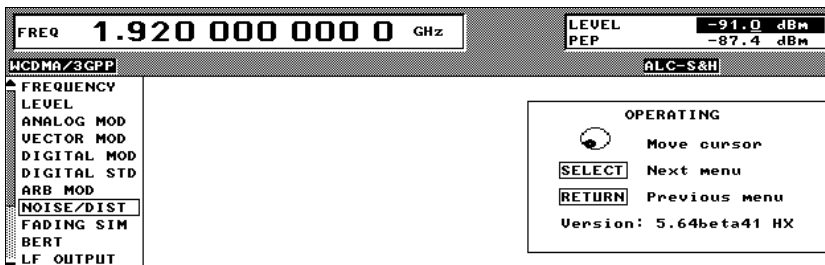

Set the carrier level to -91 dBm
 IEC/IEEE bus command:
 : SOUR: POW -91



Select menu NOISE/DIST

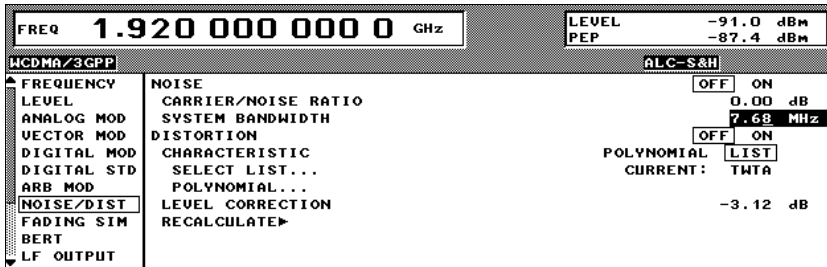

Set SYSTEM BANDWIDTH to 7.68 MHz

IEC/IEEE bus command:

:SOUR:NOIS:BAND 7.68 MHZ

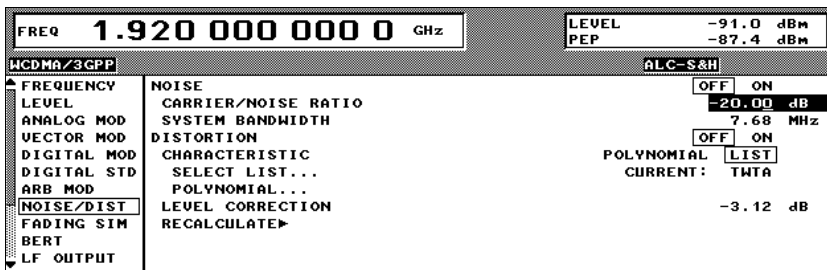

Set CARRIER TO NOISE RATIO to -21 dB

IEC/IEEE bus command:

:SOUR:NOIS:SNR -21 DB

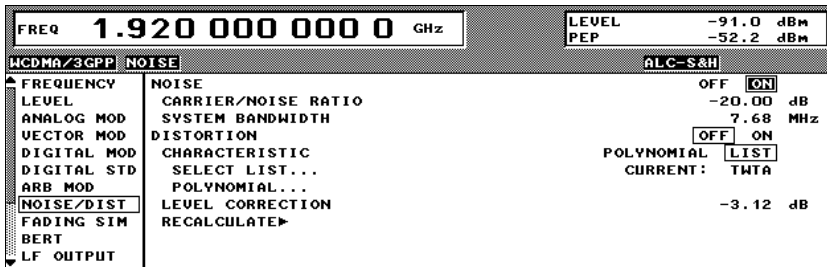

Switch on noise STATE

IEC/IEEE bus command:

:SOUR:NOIS ON

6.4 Adjacent channel selectivity

6.4.1 Test purpose and conditions

The BER of the wanted 3GPP signal is measured in the presence of an interfering 3GPP signal in the upper or lower adjacent channel. The wanted signal power is -115 dBm, the interfering signal power -52 dBm, measured at the base station input. Due to the level difference between the wanted and the interfering signal, the latter shall have an ACPR of -63 dBc or better.

The wanted 3GPP signal is again a 12.2 kbps uplink Reference Measurement Channel. For the interfering signal, the specification states “W-CDMA signal with one code”, which is not very precise. The condition can be fulfilled in a sensible way, for example, with an uplink signal in DPDCH+DPCCH mode, with one DPDCH active. As data source, use a PRBS sequence not correlated to the wanted

signal. As the wanted signal uses PN9 as user data, a different PN sequence (e.g. PN15) is recommended for the interfering signal. The interfering signal is positioned 5 MHz above or below the wanted signal.

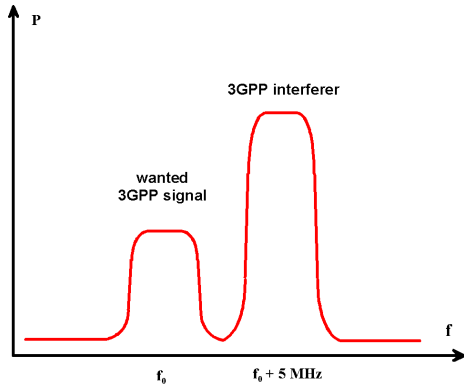

Fig. 6.4 Signal scenario for ACS measurement.

6.4.2 Test setup and generator configurations

SMIQ 1 generates the wanted signal, SMIQ 2 the interfering signal, as shown below.

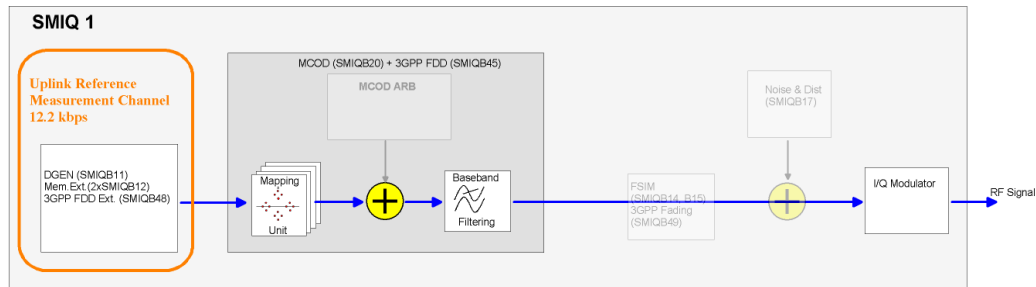

Fig. 6.5: Configuration of SMIQ 1 for adjacent channel selectivity. Option SMIQB48 generates a 12.2 kbps uplink Reference Measurement channel. The inactive parts are shaded.

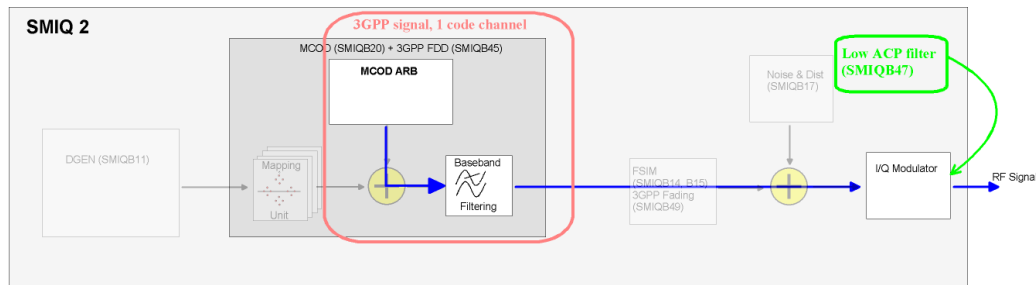

Fig. 6.6: Configuration of SMIQ 2 for adjacent channel selectivity. Option SMIQB45 generates a W-CDMA signal with one code channel. The low ACP filter option SMIQB47 is recommended for best ACP performance. The inactive parts are shaded.

6.4.3 Test procedure

Set SMIQ 1 to transmit a 12.2 kbps uplink Reference Measurement Channel.

Set SMIQ 2 to transmit an interfering 3GPP signal, as described in 4.6. As data source, use a PN sequence other than PN9, for example PN15.

Set the required carrier frequencies. Then set the RF power of SMIQ 1 to -115 dBm, the RF power of SMIQ 2 to -52 dBm.

Measure the BER and control that the measured value does not exceed the specified limit (BER < 0.001).

6.5 Blocking characteristics

6.5.1 Test purpose and conditions

This is the same scenario as for adjacent channel selectivity, except that the interfering signal is not in the adjacent channels of the wanted signal, but somewhere else. This tests the ability of the BS receiver to withstand high-level interference from unwanted signals at frequency offsets of 10 MHz or more.

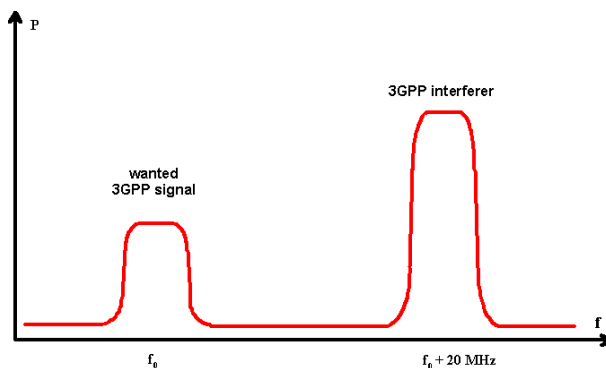

Fig. 6.7 Signal scenario for blocking characteristics measurement, here with 3GPP interferer.

The offset of the interferer from the wanted 3GPP signal varies from 10 MHz to such a value that the center frequency of the interferer covers the range from 1 MHz to 12.75 GHz. If the interferer is located in the 3GPP uplink band (1920 MHz to 1980 MHz, “in-band blocking”), use a W-CDMA signal with one code. This is also valid for the 20 MHz regions just below and above the 3GPP band. If the interferer is more than 20 MHz away from the 3GPP uplink band, use a CW signal.

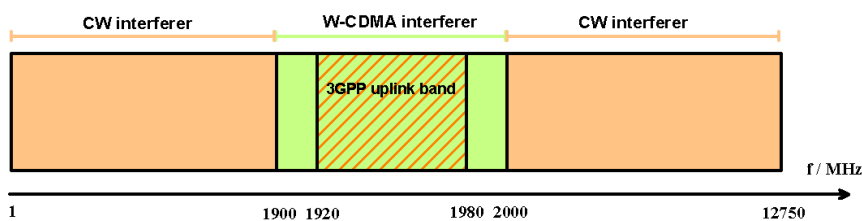

Fig. 6.8 Interferer type for different center frequencies of the interfering signal. The offset from the wanted signal is always at least 10 MHz.

The power of the wanted signal and the interfering signal are defined as shown in the following table. These values are specified for the 3GPP band:

1920 MHz – 1980 MHz for uplink

2110 MHz – 2170 MHz for downlink

3GPP also allows other frequency bands. See the specifications for details.

Table 6.2: Blocking characteristics for operation in uplink frequency band 1920 MHz – 1980 MHz.

| Center Frequency of Interfering Signal / MHz | Interfering Signal Level / dBm | Wanted Signal Level / dBm | Minimum Offset of Interfering Signal / MHz | Type of Interfering Signal |
|--|--------------------------------|---------------------------|--|-----------------------------|
| 1920 to 1980 | -40 | -115 | 10 | W-CDMA signal with one code |
| 1900 to 1920 1980 to 2000 | -40 | -115 | 10 | W-CDMA signal with one code |
| 1 to 1900 2000 to 12750 | -15 | -115 | - | CW carrier |

6.5.2 Test setup and generator configurations

This test requires all three signal generators, although SMIQ 2 and SMR are not used simultaneously.

The configurations of SMIQ 1 and SMIQ 2 are the same as in 6.4. In some cases, however, SMIQ 2 generates a CW signal rather than a W-CDMA signal. This is obtained by simply switching off the modulation (see below).

SMIQ 1 generates the wanted signal. SMIQ 2 generates the interfering signal in the following cases:

- if the interfering signal is a W-CDMA signal (center frequency between 1900 and 2000 MHz)
- if the interfering signal is CW and its center frequency is below 1900 MHz.

If the center frequency of the CW interferer is higher than 3300 MHz, the interferer is generated by SMR.

If the interferer is a CW signal, the interfering signal is 100dB stronger than the wanted signal. In this case, the interfering signal has to be filtered with an appropriate notch filter. The filter eliminates the interferer's broadband noise, which would fall into the wanted channel. For a 3GPP interferer the broadband noise shall be below -130 dBc in 1 Hz bandwidth, which is easily fulfilled by SMIQ.

6.5.3 Test procedure

Set SMIQ 1 to transmit a 12.2 kbps uplink Reference Measurement Channel.

Set SMIQ 2 to transmit an interfering 3GPP signal, as described in 4.6. As data source, use a PN sequence other than PN9, for example PN15. To switch to a CW signal, turn off the WCDMA/3GPP state (: SOUR : W3GP : STAT OFF) or use the MOD ON/OFF key on the front panel.

Set the interfering signal at a frequency offset F_{uw} from the assigned channel frequency of the wanted signal which is given by:

$$F_{uw} = \pm (n \times 1 \text{ MHz})$$

where n is increased in integer steps from $n = 10$ up to such a value that the center frequency of the interfering signal covers the range from 1 MHz to 12.75 GHz. The interfering signal level measured at the antenna connector depends on its center frequency, as specified in Table 6.2.

Measure the BER and control that the measured value does not exceed the specified limit ($BER < 0.001$).

NOTE: The test procedure requires more than 10 000 BER measurements to be carried out. To reduce the time needed for these measurements, it may be appropriate to conduct the test in two phases: During phase 1, BER measurements are made on all center frequencies of the interfering signal as requested but with a reduced confidence level, in order to identify those frequencies which require more detailed investigation. In phase 2, detailed measurements are made only at these critical frequencies, applying the required confidence level.

6.6 Intermodulation characteristics

6.6.1 Test purpose and conditions

This is another variation of testing in the presence of interfering signals. Here, two interferers, one CW and one modulated, are placed with 10 MHz and 20 MHz offset from the wanted signal, so that one of their third order intermodulation products falls into the wanted channel, according to

$$f_{IM} = 2(f_0 + 10 \text{ MHz}) - (f_0 + 20 \text{ MHz}) = f_0$$

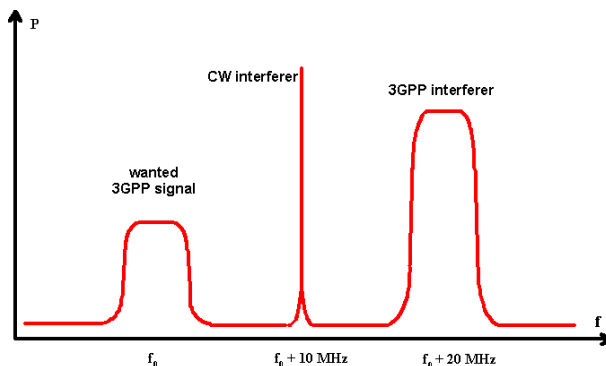

Fig. 6.9 Signal scenario for intermodulation characteristics measurement. One of the third order intermodulation products of the two interfering signals falls into the wanted channel.

This measurement shows that the BS receiver can cope with two high-level interferers at frequencies with a specific relationship to the frequency of the wanted signal. The signal levels are specified as shown in Table 6.3.

Table 6.3: Signal parameters for intermodulation characteristics measurement.

| Type of signal | Signal level / dBm | Offset / MHz |
|-----------------------------|--------------------|--------------|
| Wanted signal | -115 | - |
| CW signal | -48 | 10 |
| W-CDMA signal with one code | -48 | 20 |

6.6.2 Test setup

The setup is the same as for blocking characteristics, but this time all three signal generators are active at the same time. SMIQ 1 generates the wanted signal, SMIQ 2 the 3GPP interferer and SMR the CW interferer.

6.6.3 Test procedure

Set SMIQ 1 to transmit a 12.2 kbps uplink Reference Measurement Channel.

Set SMIQ 2 to transmit an interfering 3GPP signal, as described in 4.6. As data source, use a PN sequence other than PN9, for example PN15.

Set SMR to transmit a CW signal.

Set the required carrier frequencies and powers (see Table 6.3). The CW signal lies 10 MHz, the 3GPP interferer 20 MHz above the wanted signal.

Measure the BER and control that the measured value does not exceed the specified limit ($BER < 0.001$). Then repeat the measurement with offsets -10 MHz and -20 MHz.

6.7 Spurious emissions

This test measures the emissions generated or amplified in the receiver itself that appear at the antenna connector of the BS. Thus, no signal generator is needed for this test.

6.8 Verification of the internal BER calculation

6.8.1 Test purpose and conditions

Base stations with internal BER calculations can synchronise their receivers to known pseudo-random data sequences and calculate the BER from the received data. This test is performed only if the BS has this feature. All data rates used in Receiver Characteristics tests are also used in this verification test. This test is performed by feeding an RMC with known BER to the input of the receiver. Locations of the erroneous bits shall be randomly distributed within a frame. Erroneous bits are inserted to the data bit stream as shown in Fig. 6.10. The information data is a PN 9 sequence (or a longer PN).

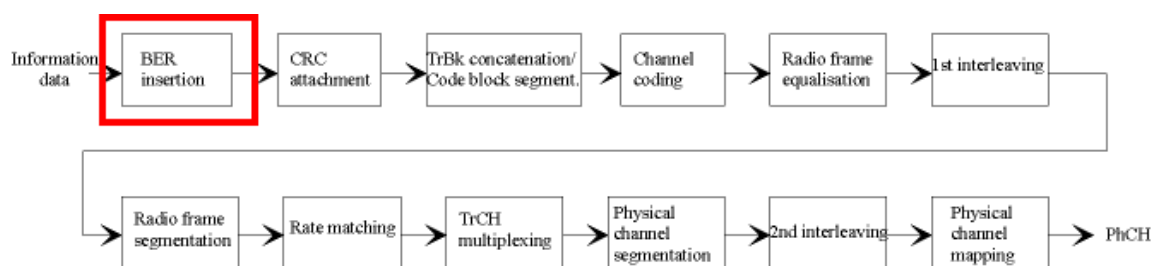

Fig. 6.10: BER insertion in the RMC. Erroneous bits are randomly distributed within the information data blocks before the CRC is calculated.

The signal level at the BS receiver inputs must be 10 dB higher than the value obtained in the reference sensitivity level test, i.e. -111 dBm (see 6.2). The BER indicated by the BS must not deviate more than 10% from the BER generated by the signal source, as shown in Table 6.4.

Table 6.4: BER to be set in the signal source for verification of internal BER calculation.

| RMC data rate / kbps | BER |
|----------------------|------|
| 12.2 | 0.01 |

6.8.2 Test setup

Only SMIQ 1 is active and transmits a 12.2 kbps RMC with a defined BER.

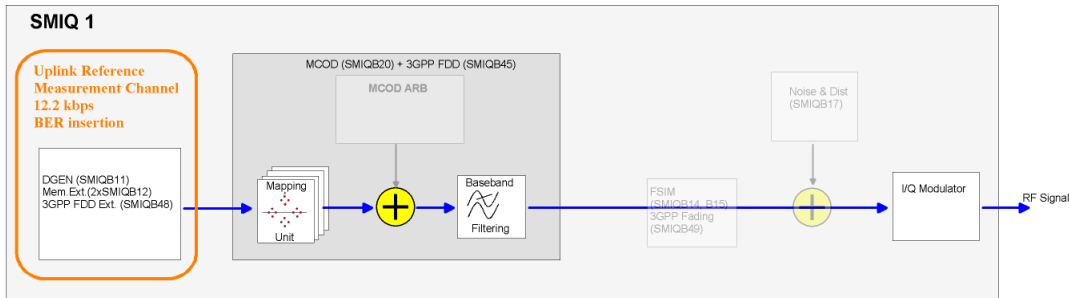

Fig. 6.11: Configuration of SMIQ 1 for verification of internal BER calculation.

6.8.3 Test procedure

Set SMIQ 1 to transmit a 12.2 kbps RMC with defined BER as described in 4.5.

Measure the BER with the BS internal BER tester over at least 50,000 bits.

7 Performance Requirements to 3GPP TS 25.141

7.1 General remarks

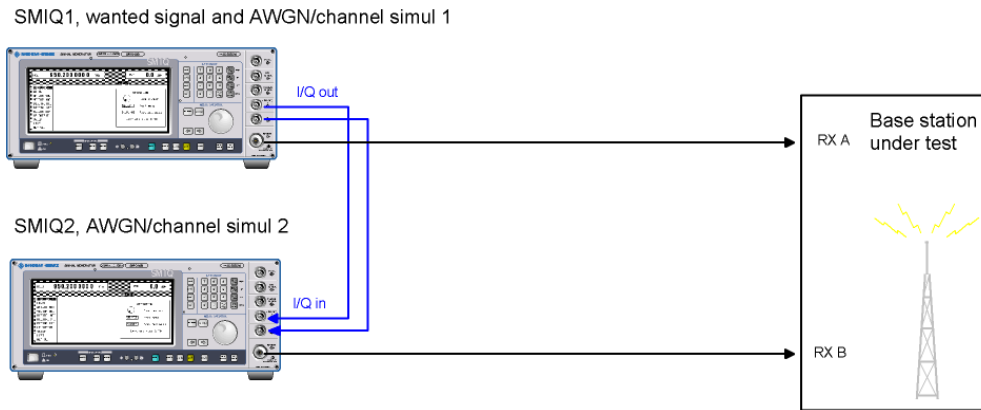

Fig. 7.1: Test setup for Performance Requirements tests. SMIQ 1 generates the Reference Measurement Channel and provides fading and AWGN for the first channel. To simulate the second channel, the I/Q signal from SMIQ 1 is connected to I/Q IN of SMIQ 2, also equipped with fading and AWGN capabilities. Note that the I/Q connectors on the SMIQ front panel are combined inputs and outputs.

The wanted 3GPP signal is again an uplink Reference Measurement Channel. The information bit rate can be 12.2 kbps, 64 kbps, 144 kbps or 384 kbps. The tests are performed for all Reference Measurement Channels supported by the base station. In Performance Requirements tests, the block error rate (BLER) rather than the BER is measured. As these are tests in real-environment conditions, the received signal has to be analyzed in the same way as by the base station receiver during operation in the network.

7.2 Demodulation of DCH in static propagation conditions

7.2.1 Test purpose and conditions

This test verifies whether the receiver can demodulate and decode the test signal under static propagation conditions with a BLER not exceeding a specified limit.

The AWGN signal is set to -84 dBm in 3.84 MHz bandwidth. The wanted signal is set to

$$P_{wanted} = -84 \text{ dBm} + 10 \cdot \log_{10} \left(\frac{R_b}{3.84 \cdot 10^6} \right) + \frac{E_b}{N_0}$$

where R_b is the bit rate of the RMC transmitted as wanted signal. E_b / N_0 is the relation of the wanted signal's energy to noise energy, standardized to one bit. The 3GPP specifications define E_b / N_0 values, at which the Block Error Rate shall not exceed specific limits. For example, the BLER shall be smaller than 10^{-2} for a 12.2 kbps RMC with $E_b / N_0 = 5.1$ dB. Then, the level of the wanted signal is $P_{wanted} = -103.9$ dBm, according to the equation above. The values for all test cases can be found in TS 25.141.

7.2.2 Test setup and generator configurations

SMIQ 1 generates the wanted 3GPP signal and provides the RF signal (including AWGN and fading) for antenna port A. In addition, the I/Q baseband signal from SMIQ 1 is connected to SMIQ 2, which is driven in external vector modulation mode and provides the signal for antenna port B (see Fig. 7.1 and Fig. 7.2).

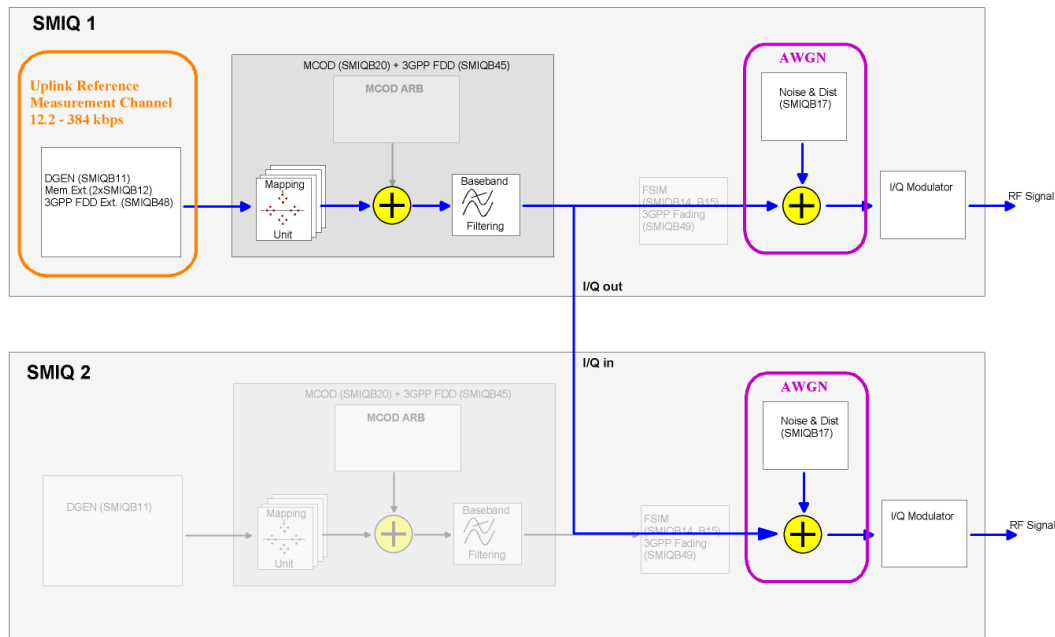

Fig. 7.2: Configuration of SMIQ 1 and SMIQ 2 for demodulation in static propagation conditions. The bold arrows and boxes denote the active parts in both SMIQs. Inactive parts are shaded.

7.2.3 Calculating the carrier-to-noise ratio

The AWGN levels stated in the 3GPP specifications are standardized to the 3.84 MHz bandwidth. On the other hand, the AWGN bandwidth shall be at least $3.84 \text{ MHz} \cdot 1.5 = 5.76 \text{ MHz}$. In SMIQ, the carrier-to-noise ratio and the noise bandwidth are given as parameters. The carrier power is the value shown in SMIQ's level indicator. The noise power is the power of the noise signal in the entire bandwidth.

In all Performance Requirements tests, the AWGN signal has -84 dBm in 3.84 MHz. If the noise bandwidth is chosen to be $3.84 \text{ MHz} \cdot 2 = 7.68 \text{ MHz}$, the noise power in the entire bandwidth is -81 dBm. If we take the example of $P_{\text{wanted}} = -103.9 \text{ dBm}$ from above, we obtain $C/N = -22.9 \text{ dB}$.

7.2.4 Setting AWGN parameters

For the example above, SMIQ must be set as follows (first set an uplink RMC as described in 4.5):

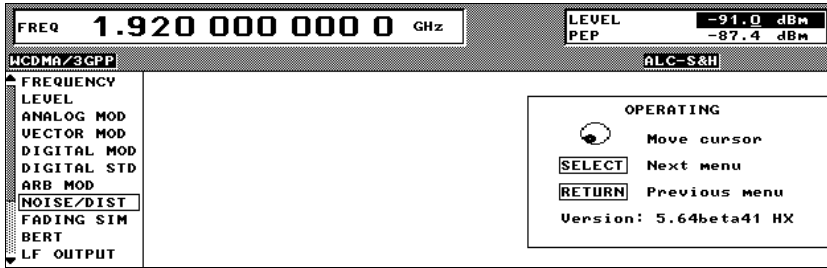

Set the carrier level to -103.9 dBm
IEC/IEEE bus command:
:SOUR:POW -103.9

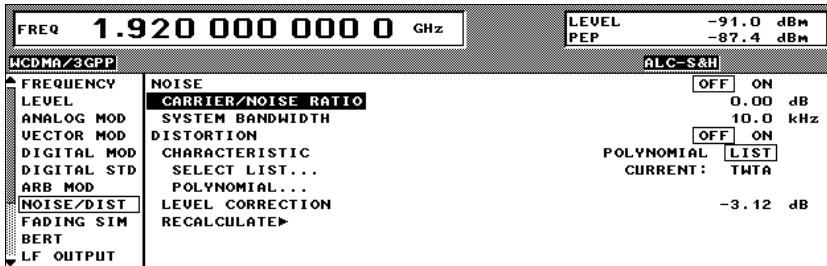

Select menu NOISE/DIST

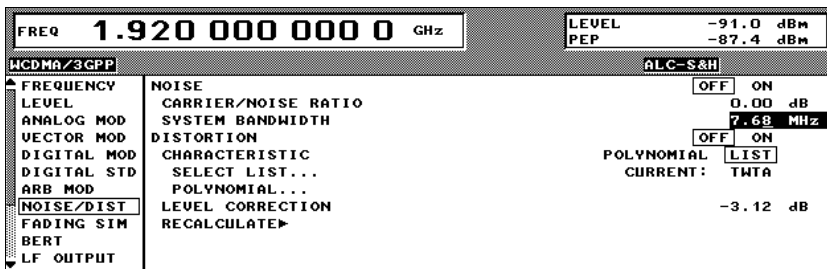

Set SYSTEM BANDWIDTH to 7.68 MHz
IEC/IEEE bus command:
:SOUR:NOIS:BAND 7.68 MHz

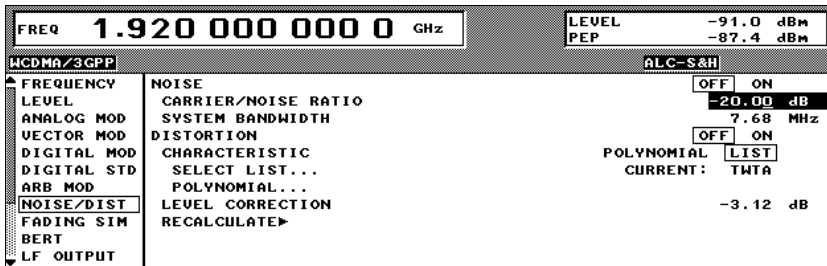

Set CARRIER TO NOISE RATIO to -22.9 dB
IEC/IEEE bus command:
:SOUR:NOIS:SNR -22.9 DB

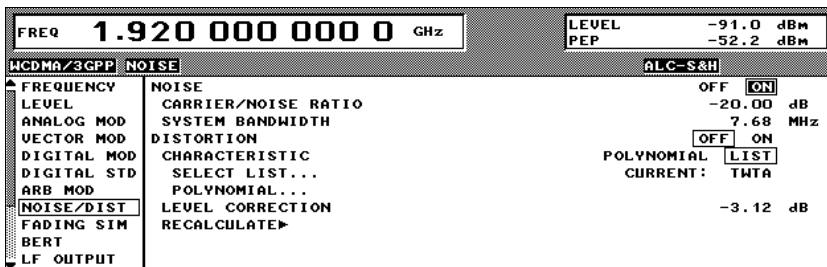

Switch on noise STATE
IEC/IEEE bus command:
:SOUR:NOIS ON

7.2.5 Setting the correct RF level of SMIQ 2

SMIQ 2 is operated in vector modulation mode (external I/Q signal). The parameter CREST FACTOR in the menu VECTOR MOD must be set to get (and display) the correct RF level.

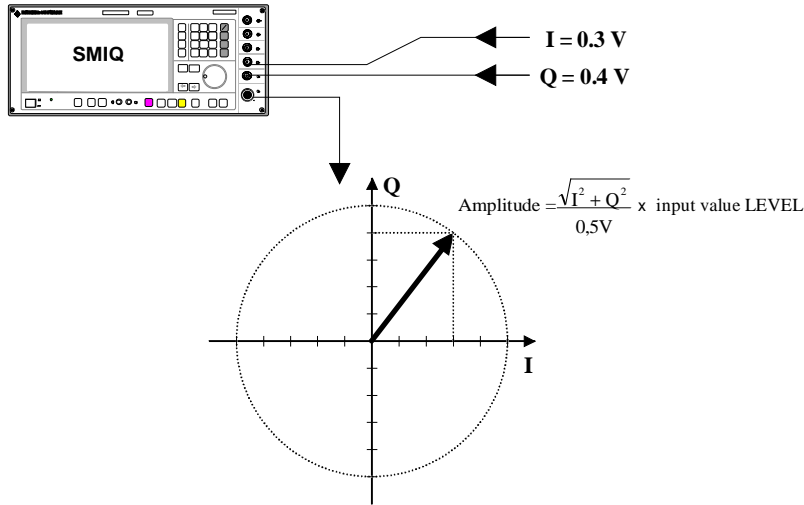

Fig. 7.3: Relation of SMIQ RF level and I/Q signal in vector modulation mode.

If the I/Q modulator is driven by a constant sum vector modulation of $\sqrt{I^2 + Q^2} = 0.5V$ the actual RF level corresponds to the displayed RF level. To avoid the I/Q modulator being overdriven, take care that the sum vector never exceeds 0.5 V when digital modulation modes with amplitude modulation components such as QPSK are used. For full-scale input, the peak envelope power of the modulated RF signal is equal to the indicated LEVEL. The average power is smaller. The difference is the peak to average ratio of the applied I/Q signal. In our case, this is the peak to average ratio of the wanted 3GPP signal. This value can be obtained from the SMIQ 1 level indication when the 3GPP state is set to ON. The peak to average ratio is the difference between the indicated PEP and the LEVEL value.

Settings of SMIQ 1:

Set SMIQ 1 to generate an RMC, as described in section 4.5.

Do not activate AWGN or Fading at this stage, as this changes the peak to average ratio of the signal.

In the LEVEL → LEVEL menu set POWER RESOLUTION to 0.01 dB

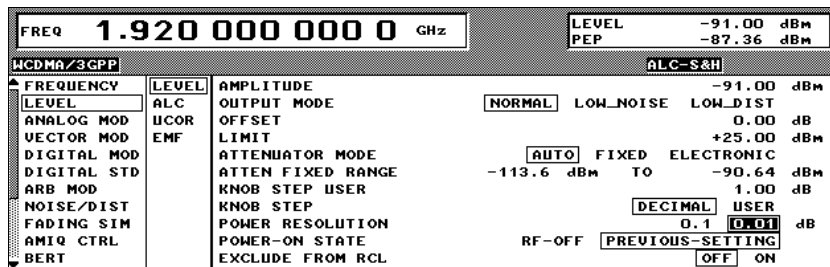

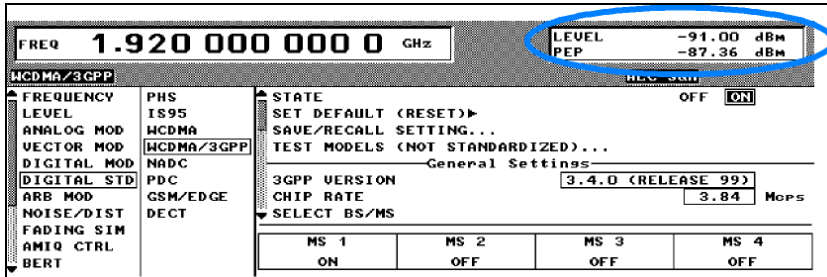

The average power and the peak envelope power are indicated on the display. The difference between the two is the peak to average ratio. Note this value.

IEC/IEEE bus command:

:SOUR:POW:PEP?

Settings of SMIQ 2:

Connect the I/Q outputs on the front panel of SMIQ 1 to the I/Q inputs of SMIQ 2. (The connectors on the front panel are combined in- and outputs.) Set the same RF level as for SMIQ 1.

Do not activate AWGN or Fading at this stage, as this changes the peak to average ratio of the signal.



In the VECTOR MOD menu of SMIQ 2 set CREST FACTOR to the value noted before (peak to average ratio of the wanted signal)

IEC/IEEE bus command:

:SOUR:DM:IQ:CRES 3.64



Switch on STATE. The display of SMIQ 2 shows the same PEP value as SMIQ 1.

Now continue with the AWGN and fading settings for both SMIQ.

7.2.6 Test procedure

Set SMIQ 1 to transmit an RMC as described in 4.5.

Set the RF levels of both SMIQ 1 and SMIQ 2 to the desired value (level of the wanted signal). Set the crest factor parameter in SMIQ 2 as described above to get a correct RF level.

Activate noise generation in both SMIQ 1 and SMIQ 2 and set the C/N parameter to the desired value, as described above.

7.3 Demodulation of DCH in multipath fading conditions

7.3.1 Test purpose and conditions

This test uses "classical" fading scenarios, similar to other mobile communication standards. The standard [2] defines four different cases, simulating multipath scenarios with up to four paths (see Table 7.1). Cases 1 and 2 simulate a mobile carried by a moving pedestrian. Cases 3 and 4 correspond to faster moving objects as cars or trains.

Table 7.1: Propagation conditions for multipath fading

| Case 1, speed 3 km/h | | Case 2, speed 3 km/h | | Case 3, speed 120 km/h | | Case 4, speed 250 km/h | |
|----------------------|--------------------|----------------------|--------------------|------------------------|--------------------|------------------------|--------------------|
| Relative Delay / ns | Average Power / dB | Relative Delay / ns | Average Power / dB | Relative Delay / ns | Average Power / dB | Relative Delay / ns | Average Power / dB |
| 0 | 0 | 0 | 0 | 0 | 0 | 0 | 0 |
| 976 | -10 | 976 | 0 | 260 | -3 | 260 | -3 |
| | | 20000 | 0 | 521 | -6 | 521 | -6 |
| | | | | 781 | -9 | 781 | -9 |

7.3.2 Test setup

SMIQ 1 generates the wanted 3GPP signal and provides the RF signal (including AWGN and fading) for antenna port A. In addition, the I/Q baseband signal from SMIQ 1 is connected to SMIQ 2, which is driven in external vector modulation mode and provides the signal for antenna port B.

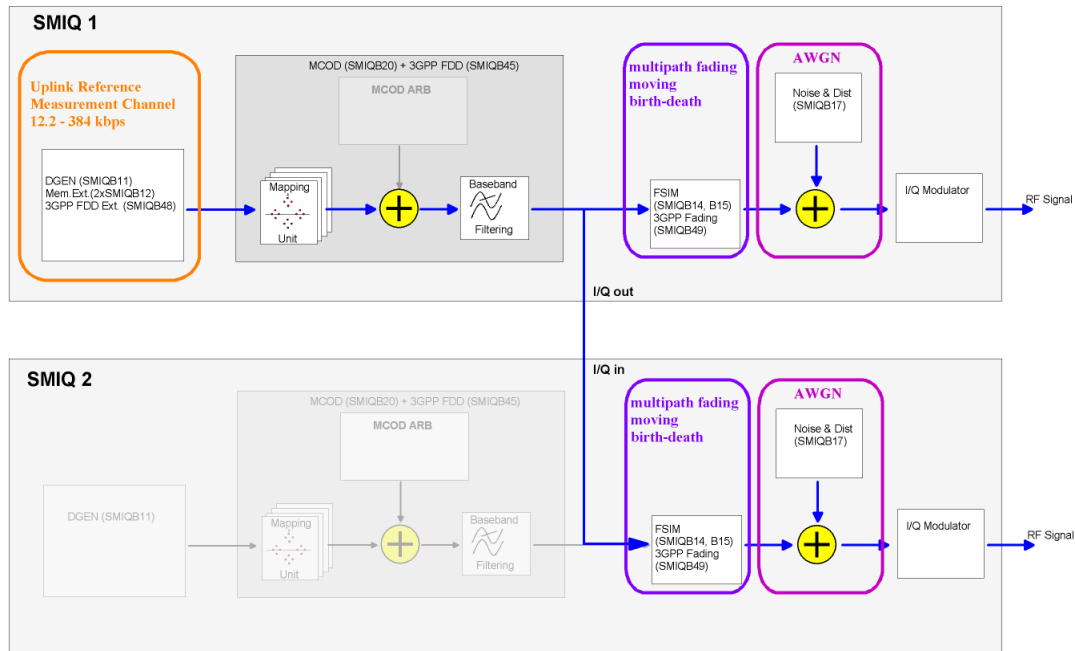
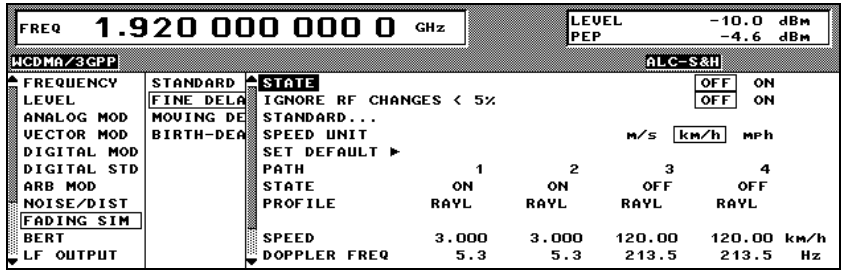
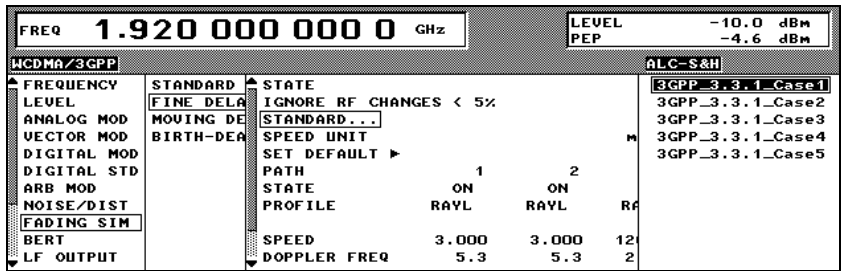

Fig. 7.4: Configuration of SMIQ 1 and SMIQ 2 for demodulation in multipath fading conditions. The bold arrows and boxes denote the active parts in both SMIQs. Inactive parts are shaded.

7.3.3 Setting SMIQ for multipath propagation



Select menu FADING SIM → FINE DELAY



Either use the predefined settings: Select STANDARD... and choose the appropriate case

IEC/IEEE bus command:

: SOUR:FSIM:FDEL:STAN G3C1

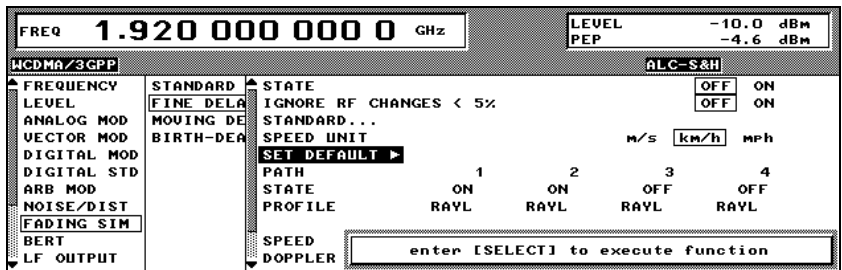

Or set the parameters manually (here case 1, as described in 7.3):

Select SET DEFAULT

IEC/IEEE bus command:

: SOUR:FSIM:FDEL:DEF

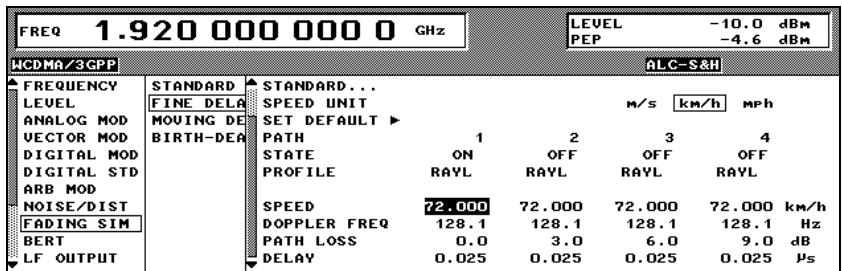

Parameters for path 1:

Set SPEED to 3 km/h and DELAY to 0.025 ms (minimum value)

IEC/IEEE bus commands:

: SOUR:FSIM:FDEL:PATH1 :

SPE 3

: SOUR:FSIM:FDEL:PATH1 :

DEL 25e-6

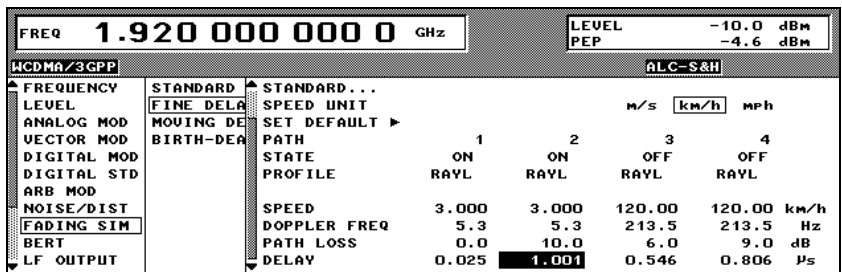

Switch on path 2

Set SPEED to 3 km/h and DELAY to 1.001 ms (so the difference between path 1 and 2 is 0.976 ms)

Set PATH LOSS to 10.0 dB

IEC/IEEE bus commands:

: SOUR:FSIM:FDEL:PATH2 :

SPE 3

: SOUR:FSIM:FDEL:PATH2 :

DEL 1.001e-3

: SOUR:FSIM:FDEL:PATH2 :

LOSS 10

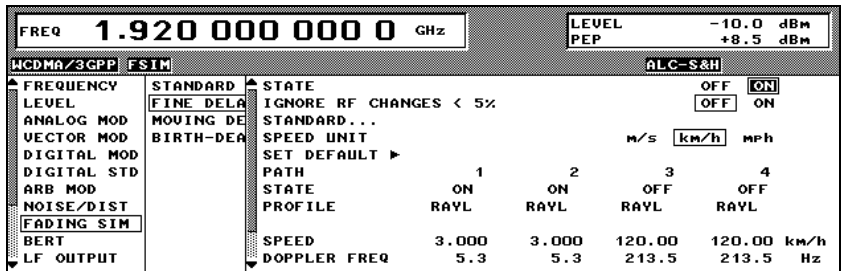

Switch on STATE.
IEC/IEEE bus command:
:SOUR:F SIM:FDEL:STAT ON

7.3.4 Test procedure

- Set SMIQ 1 to transmit an RMC as described in 4.5.
- Set the RF levels of both SMIQ 1 and SMIQ 2 to the desired value (level of the wanted signal). Set the crest factor parameter in SMIQ 2 as described in 7.2.5 to get a correct RF level.
- Activate noise generation in both SMIQ 1 and SMIQ 2 and set the C/N parameter to the desired value, as described in 7.2.4.
- Set the parameters for multipath propagation and activate fading simulation in both SMIQ 1 and SMIQ 2 as described above.

7.4 Demodulation of DCH in moving propagation conditions

7.4.1 Test purpose and conditions

This scenario has been developed to test the rake receiver of the BS. It checks if the rake receiver can adjust the delays of its "fingers" according to changing path delays. The model uses two paths with equal power and a varying delay between the two paths. Path 1 is stationary, path 2 has a delay with respect to path 1 that varies like a sinewave (see Fig. 7.5 and Table 7.2).

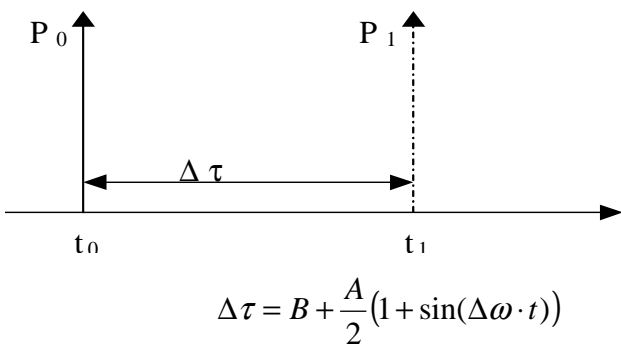

Fig. 7.5: Delay of the moving path 2 with respect to path 1.

Table 7.2: Parameters for moving propagation.

| | |
|----|---------------------------------------|
| A | 5 μs |
| B | 1 μs |
| Δω | 40 · 10 ⁻³ s ⁻¹ |

In addition, White Gaussian Noise is added to the signal. The BLER is measured as a function of the signal to noise ratio. For conformance, the BLER must not exceed the values specified in Table 7.3. For example: if the level of the wanted signal is -99.7 dBm and the relation of bit energy to noise energy is 2.1 dB, the BLER must be lower than 0.1.

Table 7.3: Performance requirements for moving propagation

| Measurement channel data rate / kbps | required BLER < 10 ⁻¹ | | required BLER < 10 ⁻² | |
|--------------------------------------|----------------------------------|--|----------------------------------|--|
| | wanted signal level / dBm | (E _b /N ₀) / dB | wanted signal level / dBm | (E _b /N ₀) / dB |
| 12.2 | n.a. | n.a. | -103.3 | 5.7 |
| 64 | -99.7 | 2.1 | -99.6 | 2.2 |

7.4.2 Test setup

The test setup and SMIQ configurations are the same as for 7.3.

7.4.3 Setting SMIQ for moving propagation

In the 3GPP specifications, the equation for the moving delay is written as:

$$\Delta\tau = B + \frac{A}{2}(1 + \sin(\Delta\omega \cdot t))$$

so that $\Delta\tau$ varies between B and B+A.

This can be rewritten as:

$$\Delta\tau = \left(DELAY_MEAN + \frac{DELAY_VARIATION}{2} \left(\sin\left(\frac{2\pi \cdot t}{VARIATION_PERIOD}\right) \right) \right)$$

with the new parameters

$$DELAY_MEAN = B + \frac{A}{2}$$

$$DELAY_VARIATION = \frac{A}{2}$$

SMIQ uses the second form, which makes more sense in defining expressive parameters. To set the values defined in the specifications (see Table 7.2) we have to set the SMIQ parameters as follows:

Table 7.4: SMIQ parameter values for moving propagation

| | |
|-------------------------|-------------|
| REFERENCE PATH | |
| PATH LOSS | 0.0 dB |
| DELAY | 1.0 μ s |
| MOVING PATH | |
| PATH LOSS | 0.0 dB |
| DELAY MEAN | 3.5 μ s |
| DELAY VARIATION (PK-PK) | 5 μ s |
| VARIATION PERIOD | 157 s |

Select menu FADING SIM → MOVING DELAY and execute the SET DEFAULT ► function.

IEC/IEEE bus command:
: SOUR:FSIM:MDEL:DEF

Set the parameters for the reference path:

DELAY MEAN = 1 µs

IEC/IEEE bus command:
: SOUR:FSIM:MDEL:REF: DEL 1e-6

Set the parameters for the moving path:

DELAY MEAN = 3.5 µs

DELAY VARIATION (PK-PK) = 5 µs

VARIATION PERIOD = 157 s

IEC/IEEE bus commands:
: SOUR:FSIM:MDEL:MOV: MEAN 3.5e-6
: SOUR:FSIM:MDEL:MOV: VAR 5e-6
: SOUR:FSIM:MDEL:MOV: VPER 157

Switch on STATE.

IEC/IEEE bus command:

: SOUR:FSIM:MDEL:STAT ON

7.4.4 Test procedure

Set SMIQ 1 to transmit an RMC as described in 4.5.

Set the RF levels of both SMIQ 1 and SMIQ 2 to the desired value (level of the wanted signal). Set the crest factor parameter in SMIQ 2 as described in 7.2.5 to get a correct RF level.

Activate noise generation in both SMIQ 1 and SMIQ 2 and set the C/N parameter to the desired value, as described in 7.2.4.

Set the parameters for moving propagation and activate fading simulation in both SMIQ 1 and SMIQ 2 as described above.

7.5 Demodulation of DCH in birth/death propagation conditions

7.5.1 Test purpose and conditions

This measurement tests how the receiver reacts to appearing and disappearing paths.

In this scenario the signal is split into two (non-fading) paths, Path 1 and Path 2 which alternate between 'birth' and 'death'. The positions where the paths appear are randomly selected with an equal probability rate and are shown in Fig. 7.6.

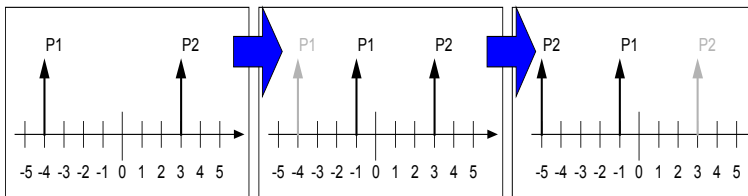

Fig. 7.6: Birth-Death propagation sequence.

Two paths, Path 1 and Path 2 are randomly selected from the group $[-5, -4, -3, -2, -1, 0, 1, 2, 3, 4, 5]$ μs . The paths have equal strengths and equal phases.

After 191 ms, Path 1 vanishes and reappears immediately at a new location randomly selected from the group $[-5, -4, -3, -2, -1, 0, 1, 2, 3, 4, 5]$ μs but excludes the point Path 2.

After an additional 191 ms, Path 2 vanishes and reappears immediately at a new location randomly selected from the group $[-5, -4, -3, -2, -1, 0, 1, 2, 3, 4, 5]$ μs but excludes the point Path 1.

The sequence in 2) and 3) is repeated.

The Performance Requirements are shown in Table 7.5. For example: if the level of the wanted signal is -97.7 dBm and the relation of bit energy to noise energy is 4.1 dB, the BLER must be lower than 0.1.

Table 7.5: Performance requirements for birth-death propagation.

| Measurement channel data rate / kbps | required BLER < 10^{-1} | | required BLER < 10^{-2} | |
|--------------------------------------|---------------------------|------------------|---------------------------|------------------|
| | wanted signal level / dBm | (E_b/N_0) / dB | wanted signal level / dBm | (E_b/N_0) / dB |
| 12.2 | n.a. | n.a. | -101.3 | 7.7 |
| 64 | -97.7 | 4.1 | -97.6 | 4.2 |

7.5.2 Test setup

The test setup is the same as in 7.3.

7.5.3 Setting SMIQ for birth/death propagation

Select menu FADING SIM → BIRTH-DEATH and execute the SET DEFAULT ► function.

IEC/IEEE bus command:
: SOUR:FSIM:BIRT:DEF

Set FREQ RATIO to 0 for both paths. This generates "non-fading" paths as defined in the specifications.

IEC/IEEE bus commands:
: SOUR:FSIM:BIRT:PATH1 :
FRAT 0
: SOUR:FSIM:BIRT:PATH2 :
FRAT 0

Set DOPPLER FREQ of path 1 to 0.1 Hz (minimum value). Path 2 is automatically set.

IEC/IEEE bus command:
: SOUR:FSIM:BIRT:PATH1 :
FDOP 0.1

Set the following parameters for path 1 (path 2 is automatically set):

PATH LOSS = 0 dB
DELAY = 5.0 μs
HOPPING DWELL = 191 ms
IEC/IEEE bus commands:
: SOUR:FSIM:BIRT:PATH1 :
LOSS 0
: SOUR:FSIM:BIRT:PATH1 :
DEL 5e-6
: SOUR:FSIM:BIRT:PATH1 :
HOPP:DWEL 191

Switch on STATE.

IEC/IEEE bus command:
: SOUR:FSIM:BIRT:STAT ON

7.5.4 Test procedure

Set SMIQ 1 to transmit an RMC as described in 4.5.

Set the RF levels of both SMIQ 1 and SMIQ 2 to the desired value (level of the wanted signal). Set the crest factor parameter in SMIQ 2 as described in 7.2.5 to get a correct RF level.

Activate noise generation in both SMIQ 1 and SMIQ 2 and set the C/N parameter to the desired value, as described in 7.2.4.

Set the parameters for birth/death propagation and activate fading simulation in both SMIQ 1 and SMIQ 2 as described above.

7.6 Verification of the internal BLER calculation

7.6.1 Test purpose and conditions

This test is only performed if the base station has internal BLER test capabilities. The test is for all data rates that are used in the performance tests 7.2 to 7.5. A measurement signal with known block error rate is fed to the receiver of the BS.

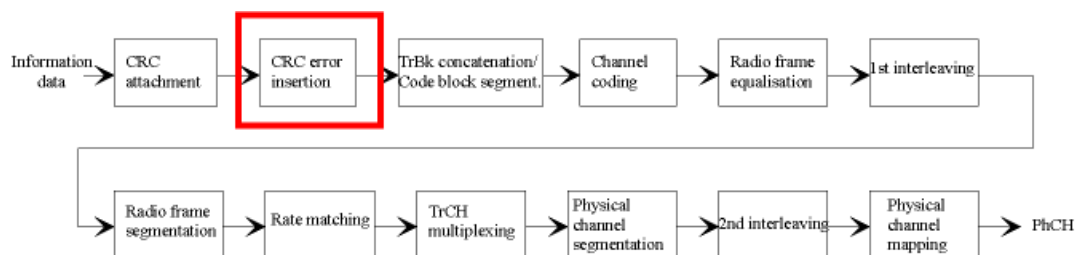

Fig. 7.7: BLER insertion in the RMC. After the CRC calculation and attachment, erroneous bits are randomly put into the CRC fields.

The signal level at the BS receiver inputs must be 10 dB higher than the value obtained in the reference sensitivity level test, i.e. -111 dBm (see 6.2). The BLER indicated by the BS shall not deviate more than 10% from the BLER generated by the signal source, as shown in Table 7.6.

Table 7.6: BLER to be set in the signal source for verification of internal BLER calculation.

| RMC data rate / kbps | BLER |
|----------------------|------|
| 12.2 | 0.01 |
| 64 | 0.01 |
| 144 | 0.01 |
| 384 | 0.01 |

7.6.2 Test setup

SMIQ 1 generates the wanted signal with a known block error rate. The signal shall be applied at both BS RX inputs for diversity reception. The setup is the same as in 7.2 or 7.3, only AWGN and fading blocks are switched off.

SMIQ1, wanted signal and AWGN/channel simul 1

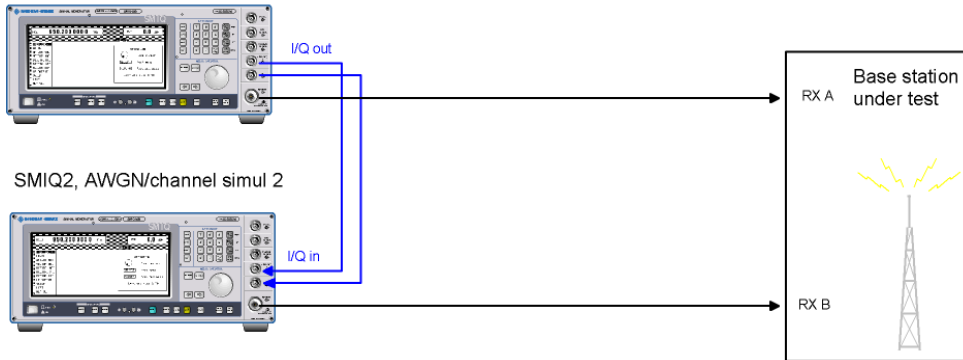

Fig. 7.8: Test setup for verification of internal BLER calculation. AWGN and channel simulation (fading) functions are switched off.

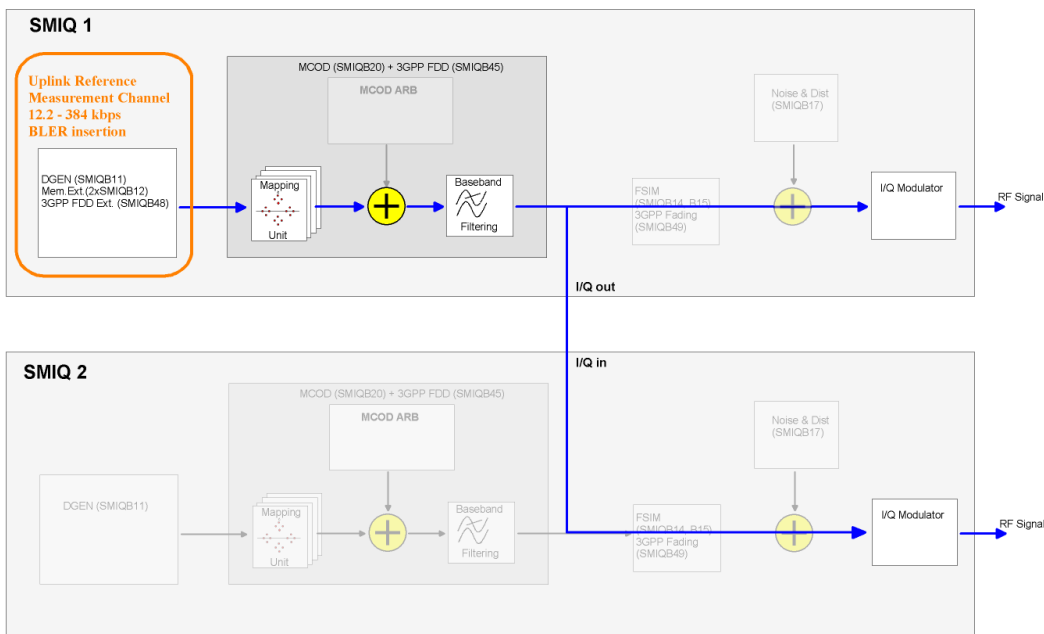

Fig. 7.9: SMIQ configuration for verification of internal BLER calculation.

Actually, this test does not require two signal generators, it could also be performed with one SMIQ and a power splitter. However, the two SMIQs are present anyway because of the other tests; and the suggested setup does not require re-switching.

7.6.3 Test procedure

Set SMIQ 1 to transmit a RMC with block errors as described in 4.5.

Set the RF levels of both SMIQ 1 and SMIQ 2 to the desired value (level of the wanted signal). Set the crest factor parameter in SMIQ 2 as described in 7.2.5 to get a correct RF level.

For each data rate to be tested, measure the BLER over at least 50,000 blocks.

8 Beyond the Standard: Additional Test Possibilities with SMIQ

This section describes some additional 3GPP features of SMIQ. They are not really required for tests to TS 25.141, but they are of interest especially for development or other “beyond-standard” applications.

8.1 Reduced setup for performance tests without receiver antenna diversity

If the performance tests are applied to a base station with only one RX port, one SMIQ is sufficient. This single SMIQ generates the wanted signal, simulates the propagation conditions, and adds AWGN.

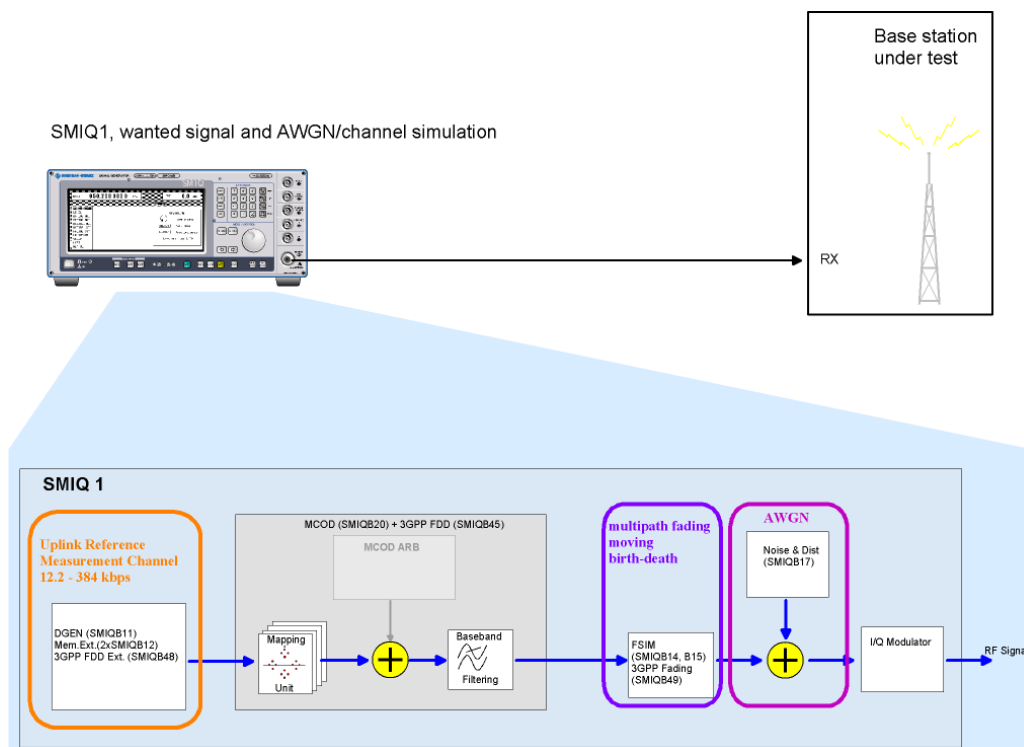

Fig. 8.1: Test setup for Performance Requirements measurements without receiver antenna diversity and active SMIQ functions.

8.2 Transmitting user-specific data

SMIQ can use other data than PN sequences for the Enhanced Channels, for example data lists that are stored in SMIQ. This function can be used, for example, to set up an RMC with special data, such as video data or user specific test sequences.

To upload data lists to SMIQ, either the SMIQ-K1 software or the WinIQSIM™ software can be used. Both programs can be downloaded from the Rohde & Schwarz website. This section can only give a

short introduction how to generate data lists. For more information, see the help documentation that comes with the programs. The following example uses WinIQSIM™.

1. Save the user specific bit stream in an ASCII File

The file format shall be as follows:

First row: ROHDE&SCHWARZ IQSIM DATA FILE

Second row: (free for comments)

Third row – end: data (only "1" and "0" are recognized)

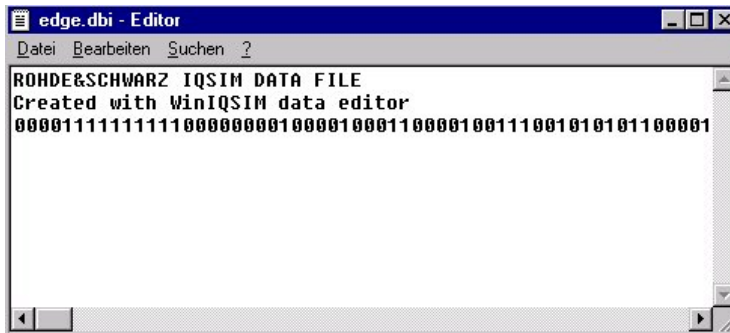

The file must have the extension .dbi.

2. Transmit the file to SMIQ as data list using WinIQSIM

In WinIQSIM™ select SMIQ(ARB) --> DLIST transmission

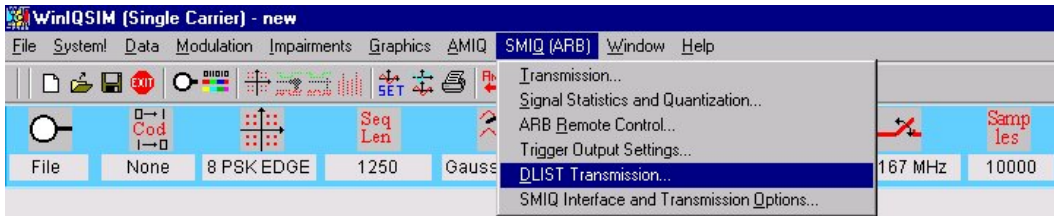

The following panel appears

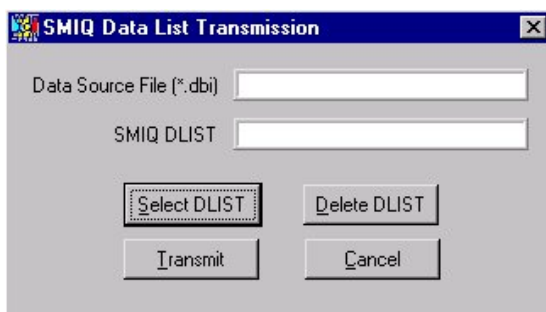

Select your .dbi file as source file and type a name for the data list in SMIQ (max. 7 characters)

3. Set up an RMC

Set the RMC as described in section 4.5, only choosing the data list as data source instead of PN 9.

| | | |
|-------------------------------------|---------------------|------------------------|
| FREQ 1.920 000 000 0 GHz | | LEVEL -10.0 dBm |
| ALC-ON | | |
| POWER DPCCH | | PN9 |
| Specific Enhanced Channels Settings | | PN11 |
| CHANNEL NUMBER | 1 E 2 E 3 E 4 E 5 E | PN15 |
| TYPE | DPDCH | PN16 |
| SYMBOL RATE | 60 | ALL0 |
| CHAN CODE | 16 | ALL1 |
| DATA DTCH | TEST1 | PAT1 |
| DATA DCCH | PN15 | TEST1 |
| CHANGE DATA | | SERVICE |

9 Abbreviations

| | |
|-------|--|
| 3GPP | Third Generation Partnership Project. Name of the organization that defines the communication standards of the Third Generation. |
| AWGN | Additional White Gaussian Noise. |
| DCCH | Dedicated Control Channel. Transport channel that is mapped to the Dedicated Physical Data Channel (DPDCH). |
| DCH | Dedicated Channel. The DTCH and DCCH are sometimes collectively called DCH. |
| DPCCH | Dedicated Physical Control Channel. Physical Channel that contains some control information. Among others, the Transmit Power Control (TPC) bits are transmitted in the DPCCH. |
| DPDCH | Dedicated Physical Data Channel. Physical Channel that contains the user data. The DPDCH is channel coded and carries the transport channels DTCH and DCCH. |
| DTCH | Dedicated Traffic Channel. Transport channel that is mapped to the Dedicated Physical Data Channel (DPDCH). |
| FDD | Frequency Division Duplex, means that uplink and downlink transmit on different frequencies. |
| OCNS | Orthogonal Channel Noise Simulation. A "realistic" 3GPP background signal consisting of a (usually large) number of code channels. |
| RMC | Reference Measurement Channel. The 3GPP specifications define uplink Reference Measurement Channels for base station conformance tests. These are 3GPP signals with defined parameter values including channel coding. RMCs contain a DPCCH and a DPDCH as physical channels. As transport channels, a DTCH and a DCCH are mapped to the DPDCH. See section 4.5 and reference [2]. |
| SFN | System Frame Number. System time unit that is transmitted by the BS in the BCH channel. |
| TPC | Transmit Power Control. TPC bits are transmitted by a base station or mobile to tell its counterpart to increase or decrease transmit power. |

10 References

- [1] W-CDMA Signal Generator Solutions by Rohde & Schwarz, Application Note 1GP39_1E, Rohde & Schwarz, 2000 (also available as brochure, PD 757.6327.21)
- [2] 3GPP specifications: TS 25.104 v4.0.0, TS 25.141 v4.0.0, 2001
- [3] Measurements on 3GPP Base Station Transmitter Signals, Application Note 1EF44, Rohde & Schwarz, 2001
- [4] PC Software SetupAccelerator, Application Note 1GP44_0E, Rohde & Schwarz, 2001
- [5] Vector Signal Generator SMIQB, Operating Manual, PD 1125.5610.12, Rohde & Schwarz (2000)
- [6] Bit Error Rate Measurements with AMIQ and WinIQSIM™, Application Note 1GP36, Rohde & Schwarz, 1998
- [7] Demonstration of BER Test with AMIQ controlled by WinIQSIM™, Application Note 1MA16, Rohde & Schwarz, 1998
- [8] Transmitter Tests on 3GPP/WCDMA/FDD Base Stations, Application Note 1MA38, Rohde & Schwarz, 2001

11 Ordering information

Vector Signal Generator:

| | | |
|---------|--------------------|--------------|
| SMIQ02B | 300 kHz to 2.2 GHz | 1125.5555.02 |
| SMIQ03B | 300 kHz to 3.3 GHz | 1125.5555.03 |
| SMIQ04B | 300 kHz to 4.4 GHz | 1125.5555.04 |
| SMIQ06B | 300 kHz to 6.4 GHz | 1125.5555.06 |

Options:

| | | |
|---------|---|--------------|
| SMIQB11 | Data Generator | 1085.4502.04 |
| SMIQB12 | Memory Extension | 1085.2800.04 |
| SMIQB14 | Fading Simulator | 1085.4002.02 |
| SMIQB15 | Second Fading Simulator for two channel or 12 path fading | 1085.4402.02 |
| SMIQB17 | Noise Generator and Distortion Simulator | 1104.9000.02 |
| SMIQB20 | Modulation Coder | 1125.5190.02 |
| SMIQB21 | BER Measurement | 1125.5490.02 |
| SMIQB45 | Digital Standard WCDMA (3GPP) | 1104.8232.02 |
| SMIQB47 | Low ACP for CDMA and WCDMA | 1125.5090.02 |
| SMIQB48 | Extended Functions for WCDMA (3GPP) | 1105.0587.02 |
| SMIQB49 | Extended Fading Functions for WCDMA (3GPP) | 1105.1083.02 |

Signal Generator

| | | |
|-------|-------------|--------------|
| SMR20 | 2 to 20 GHz | 1104.0002.20 |
| SMR27 | 2 to 27 GHz | 1104.0002.27 |
| SMR30 | 2 to 30 GHz | 1104.0002.30 |
| SMR40 | 2 to 40 GHz | 1104.0002.40 |



ROHDE & SCHWARZ

ROHDE & SCHWARZ GmbH & Co. KG · Mühldorfstraße 15 · D-81671 München · P.O.B 80 14 69 · D-81614 München · Telephone +49 89 4129 -0 · Fax +49 89 4129 - 13777 · Internet: <http://www.rohde-schwarz.com>

This application note and the supplied programs may only be used subject to the conditions of use set forth in the download area of the Rohde & Schwarz website.